

COMPLETE GUIDE TO
LOFT LADDERS
2021



Wide range
of safe and comfortable
loft ladders

30 YEARS
HOME SOLUTIONS

FAKRO

INSULATED



ENERGY-EFFICIENT

ENERGY-EFFICIENT

METAL

MAXIMUM LOAD
200 kg

WOODEN

MAXIMUM LOAD
160 kg

U=1.1
HATCH
W/m²K

U=1.1
HATCH
W/m²K

U=0.74
LOFT LADDER
W/m²K

U=0.68
LOFT LADDER
W/m²K

U=0.51
LOFT LADDER
W/m²K

SECTION

SCISSORS

SECTION

LMS	LMK	LML	LMP
STANDARD	COMFORT AND FUNCTIONALITY	ENHANCED COMFORT OF USE	FOR HIGH ROOMS
Page 28	Page 30	Page 32	Page 34

LST	LSZ
FUNCTIONALITY AND SMALL BOX DIMENSIONS	QUICK INSTALLATION AND SMALL BOX DIMENSIONS
Page 42	Page 44

LWL EXTRA	LTK ENERGY	LWT
ENHANCED COMFORT OF USE	HIGHLY ENERGY EFFICIENT	BEST INSULATION
Page 12	Page 14	Page 16



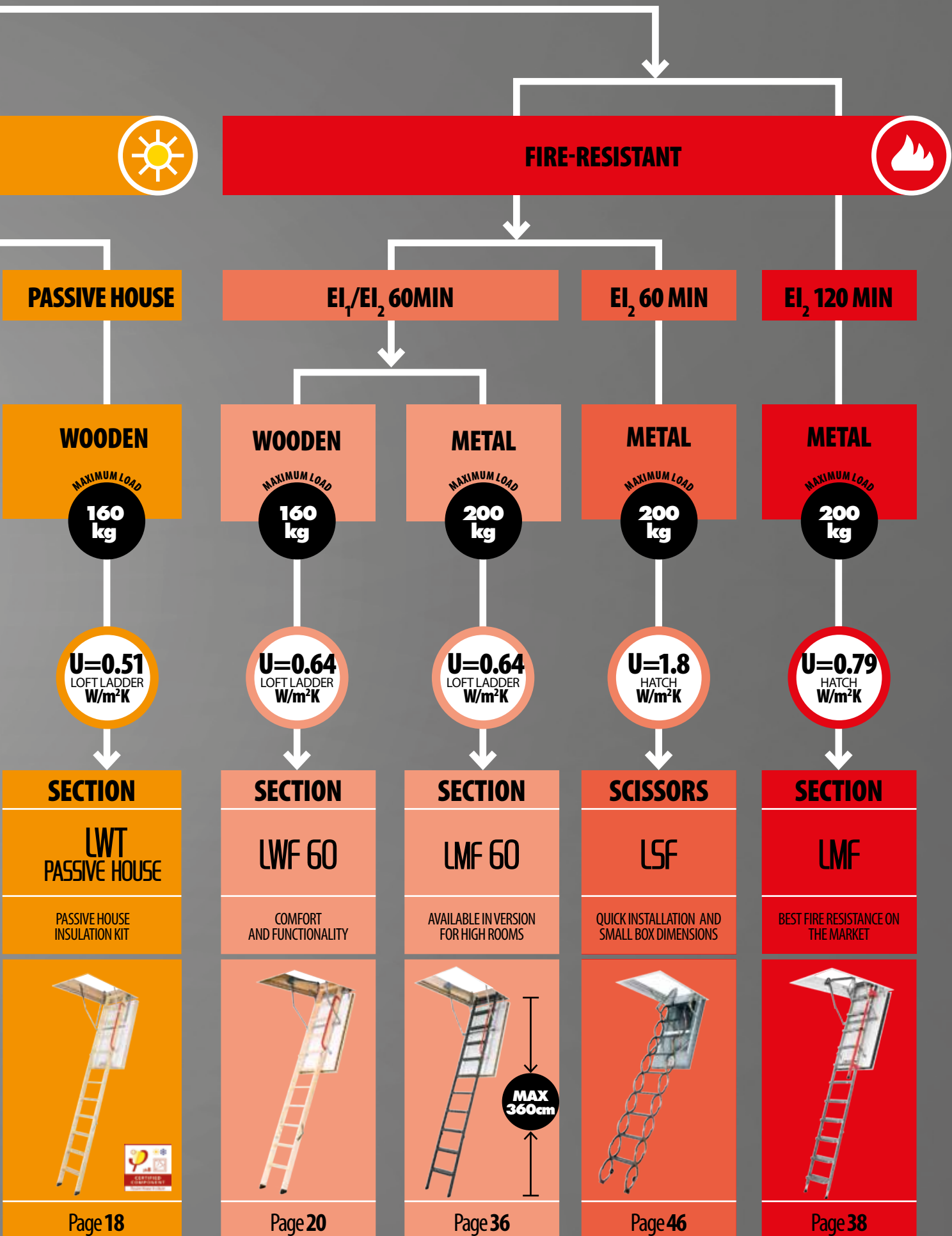





TYPES AND CHOICE OF LOFT LADDER



L-SHAPED COMBINATION DOORS

TYPES AND CHOICE OF L-SHAPED DOOR

In addition to having a wide range of loft ladders FAKRO also manufactures combination loft doors for installation in walls. These are used to provide access to unused space behind a wall or under stairs. Three models are available, the first and most basic model, the **DWK** insulating door having a 3.6cm thick sash. For added thermal efficiency and airtightness the **DWT** provides a U-value of 0.6 and offers Class 4: EN 12207 performance. Where fire resistance is required, the **DWF** offers double-sided protection (fire classification EI,45 EN 13501-2), as well as exceptional airtightness and thermal insulation.

INSULATED	HIGHLY ENERGY EFFICIENT	FIRE-RESISTANT
DWK	DWT	DWF
	 	  
		
page 48	page 50	page 52

* internal tests of the middle part of the sash

** manufacturer's internal tests for the sash

*** manufacturer's internal testing

FOLDING LOFT LADDERS

Create safe and easy access to your loft space without the need for costly and oversized staircases. FAKRO loft ladders satisfy all technical and safety requirements whilst maximizing ease of use and comfort.



SPACE SAVINGS

Thanks to their clever design, FAKRO loft ladders require little “swing space”. The ladder is mounted on the hatch so that, when folded, its sections are neatly concealed inside the loft space.

EASE OF INSTALLATION

To make installation fast and easy, FAKRO loft ladders feature a “click” fixing, enabling some ladders to be fitted by a single person. Additionally, FAKRO loft ladders can be adjusted to suit any ceiling height.

EASE OF OPERATION

The innovative spring-assisted opening mechanism (on some models ladder sections are also sprung) greatly eases ladder use. An opening rod is also supplied with every ladder.

ADDITIONAL EQUIPMENT

In order to maximise comfort and accelerate installation of the loft ladder, additional accessories are available.

WARRANTY

FAKRO loft ladders come with a **3-year warranty.**



WOODEN SECTION
LOFT LADDERS

SECTION
LOFT LADDERS

► BOX

The loft ladder has a pine or metal frame integrated within its box. It comes complete with linings which, in combination with a quick installation system gets the job done fast! The peripheral seal is used to ensure the ladder aperture remains airtight.

► HATCH MECHANISM

The used mechanism significantly simplifies ladder operation. The hatch after unlocking opens slowly without causing any hazard to the user. In addition, the mechanism maintains the hatch in fully open position, prevents it from spontaneous closing during unfolding and folding the ladder.

► HARDWARE

The patented corner hinge and spring mechanism provides added rigidity to the box and prevents distortion.

► HATCH

The sandwich type hatch can be insulated or fire-resistant.

► TREAD

The grooves on the tread surface protect the user from accidental slipping while using the ladder.

► LADDER

The ladder is made of high quality pine and consists of three or four segments.

► STILE ENDS

made from heavy duty PVC, these protect the floor surface from scratching while also adding to the ladder's overall stability (refers to 3-section ladders)

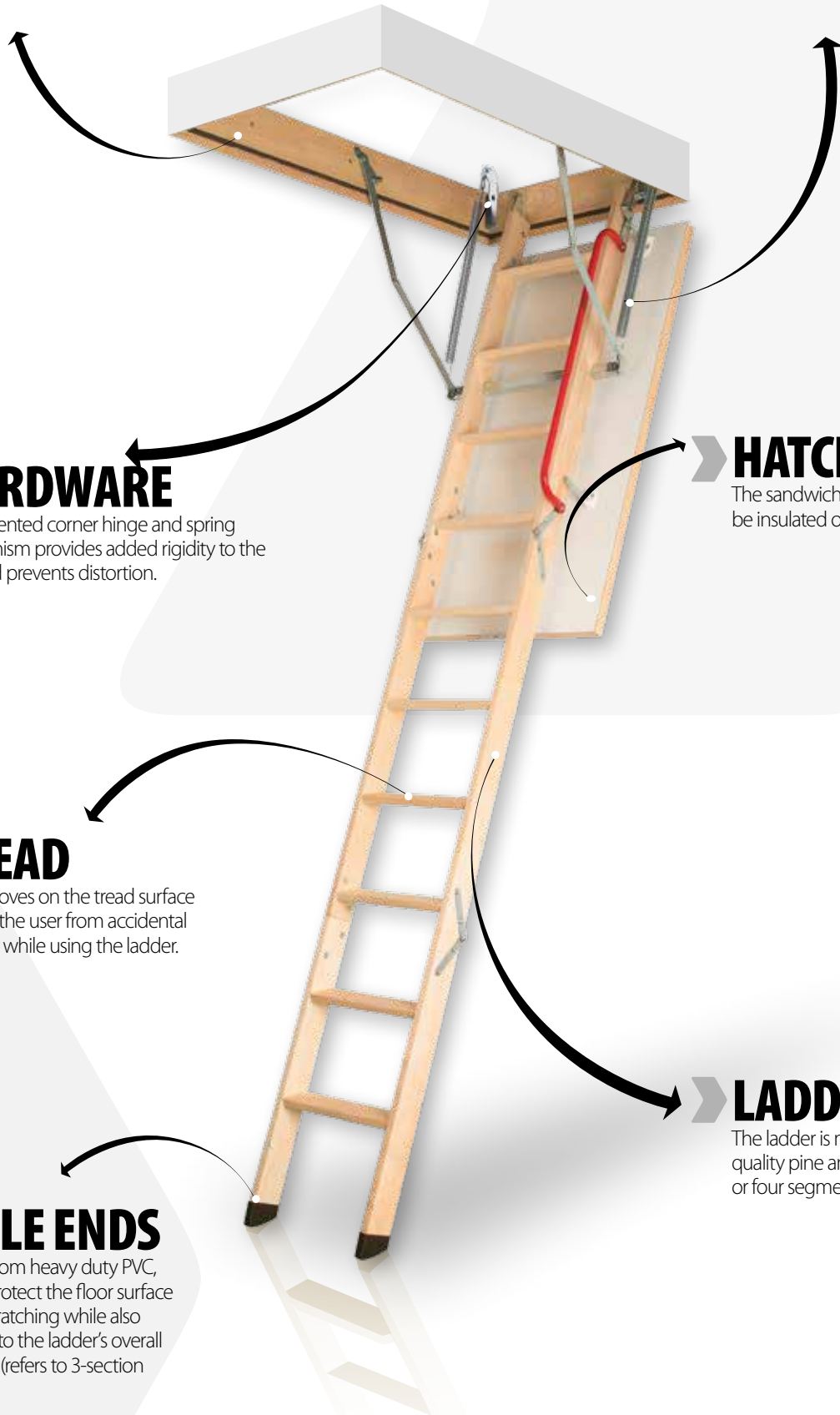

WOODEN
LOFT LADDERS



WOODEN FOLDING SECTION LOFT LADDERS

LWK
KOMFORT

U=1.1
HATCH
W/m²K

STANDARD
EN
14975

The **LWK Komfort** ladder's innovative design ensures ease of use, a high insulation value and quick installation. It is equipped with an aesthetically pleasing, smooth white finish to the hatch, and a handrail as standard.

Insulated white hatch and handrail.

As the hatch is opened the hinge moves it away from the ladder, thus increasing space for added convenience.

Light hatch weight and method of 'click fixing' makes installation very simple.

CLICK



stile ends (only in 3-section version)



handrail



white hatch



non-slip treads set flush with ladder strings



peripheral seal



easy installation



possibility of installing additional accessories, pages 54-59

Technical specification:
permissible load of 160 kg
hatch heat transmission coefficient U = 1.1 W / m²K
insulation thickness 3 cm
hatch thickness 3.6 cm

fully assembled,
and ready for quick
installation in the ceiling



3 years
WARRANTY

LWK KOMFORT LADDER DIAGRAM

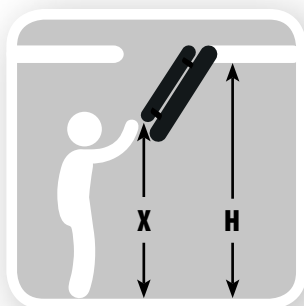

i 3-segment ladder can be equipped with the LXM ladder unloading mechanism (page 58), so that the ladder can be fully operated with a rod

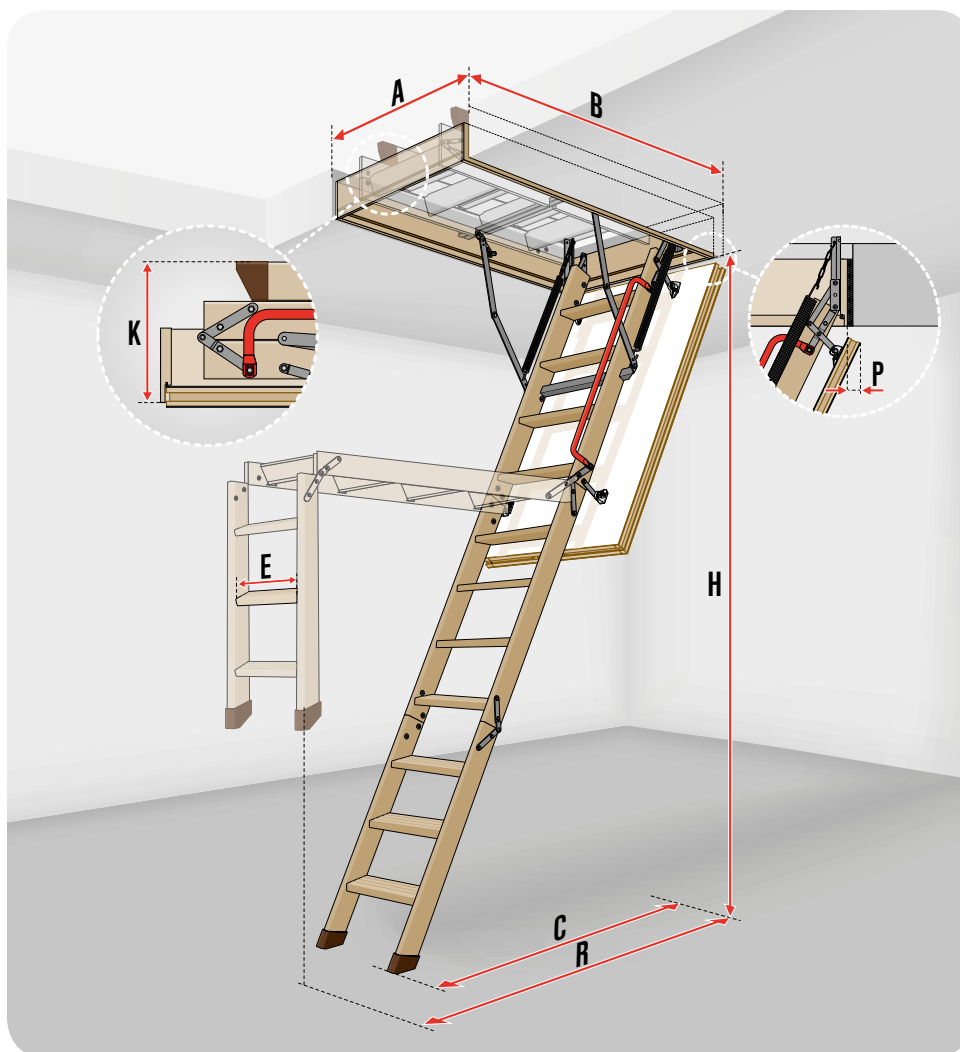

LWK Komfort LOFT LADDER DIMENSIONS

Ceiling opening dimensions [cm]	AxB	55x111	60x94	60x100	60x111	60x120	60x130	70x94	70x100	70x111	70x120	70x130	70x140	80x120	60x130	60x140	70x130	70x140
Maximum room height [cm]	H	280														305		
Minimum room height [cm]*	H _{min.}	232	250		232		250			232							246	
Height to be reached to operate the ladder [cm]	X	215 i	240		215 i		240			215 i							225 i	
Box external dimensions [cm]		53x109.4	58x92.4	58x98.4	58x109.4	58x118.4	58x128.4	68x92.4	68x98.4	68x109.4	68x118.4	68x128.4	68x138.4	78x118.4	58x128.4	58x138.4	68x128.4	68x138.4
Internal box dimensions [cm]		49x105	54x88	54x94	54x105	54x114	54x124	64x88	64x94	64x105	64x114	64x124	64x134	74x114	54x124	54x134	64x124	64x134
Folded ladder height [cm]	K	27	35		27		35							27				
Swing space [cm]	R	153	128	153	156	128	153			156							175	
Distance after ladder unfolding [cm]	C	113	114	113	120	114	113			120							135	
Hatch retraction after opening [cm]	P									4								
Box height [cm]										14								
Number of segments		3	4		3		4							3				

LADDER PARAMETERS

Tread length [cm]	E	30								34								
Tread width [cm]										8								
Distance between treads [cm]										25								
Tread thickness [cm]										2								

* for rooms lower than the maximum standard height H please adjust the length of the ladder according to the assembly instructions

LOFT LADDER DIMENSIONS

Commercial sizes [cm]		55x111	60x94	60x100	60x111	60x120	60x130	70x94	70x100	70x111	70x120	70x130	70x140	80x120	60x130	60x140	70x130	70x140
Room height [cm]	H	280														305		
Code		864521	864507	864506	864504	864501	864502	864502	864517	864516	864514	864511	864512	864593	864551	864552	864553	864554

For LWK Komfort non-standard sizes page 24



WOODEN SECTION LOFT LADDERS

**LWZ
PLUS**



Quick-fit brackets built into steel frame speeds up installation and makes levelling within the ceiling easy.



Integrated architrave lining gives a highly pleasing finish to the installed ladder.



Hinge controls hatch movement and moves it away from the ladder sections for greater ease of use.



U=1.1
HATCH
W/m²K



STANDARD
EN 14975



The **LWZ Plus** loft ladder combines the advantages of the latest design and quick fitting. The integrated steel frame, installation brackets and metal architrave lining make installation simple and finish off any imperfections and gaps between frame and ceiling.



stile ends



white hatch



architrave



peripheral seal



handrail



non-slip treads



system of quick installation in the ceiling



possibility of installing additional accessories pages 54-59

Technical specification:
permissible load of 160 kg
hatch heat transmission coefficient U = 1.1 W / m²K
insulation thickness 3 cm
hatch thickness 3.6 cm

fully assembled,
and ready for quick
installation in the ceiling



LWZ PLUS LADDER DIAGRAM

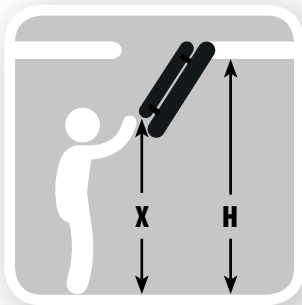

i 3-segment ladder can be equipped with the LXM ladder unloading mechanism (page 58), so that the ladder can be fully operated with a rod

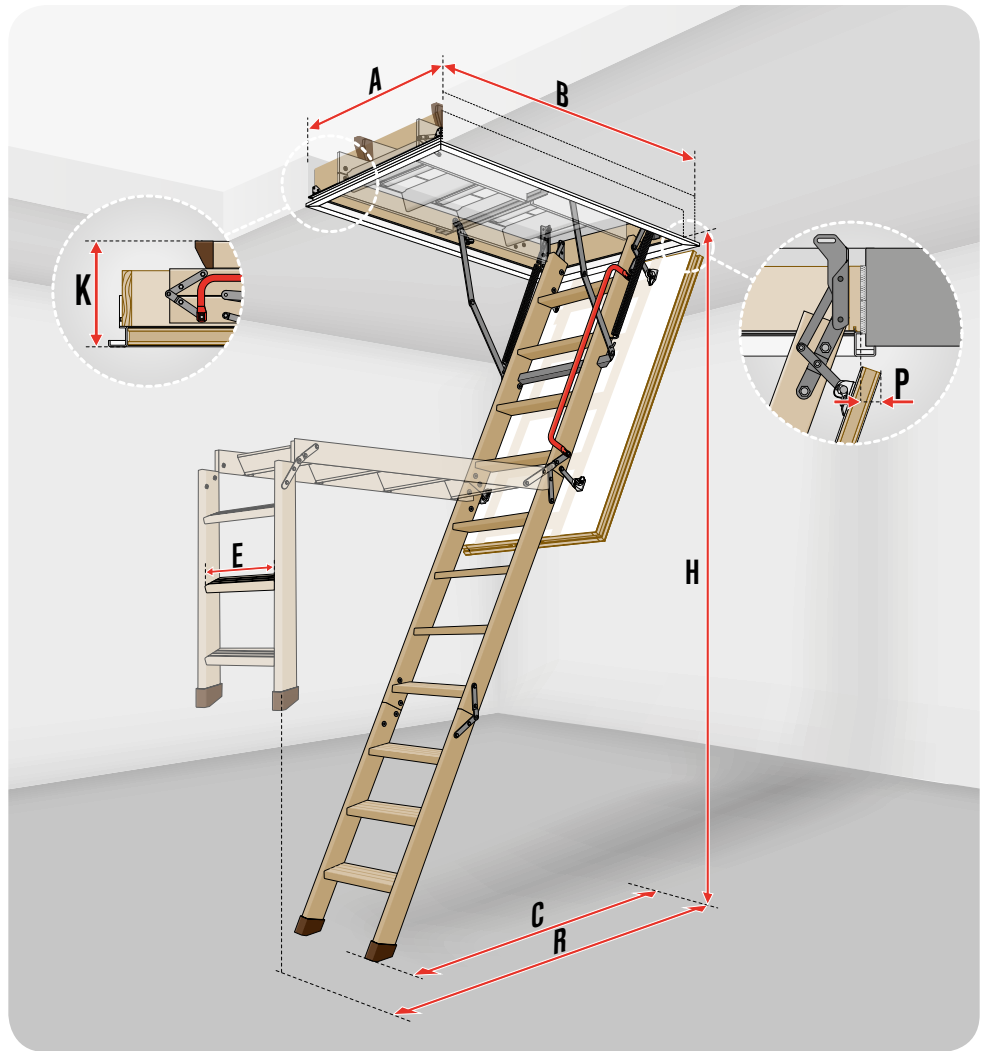

LWZ Plus LOFT LADDER DIMENSIONS

Ceiling opening dimensions [cm]	AxB	60x120	70x120	70x130	70x140	60x130	70x130	70x140
Maximum room height [cm]	H		280				305	
Minimum room height [cm]*	H _{min.}		232				246	
Height to be reached to operate the ladder [cm]	X		215	i			240	i
Box external dimensions [cm]		58.8 x 118.8	68.8 x 118.8	68.8 x 128.8	68.8 x 138.8	58.8 x 128.8	68.8 x 128.8	68.8 x 138.8
Box external dimensions with architrave linings		62.9 x 122.9	72.9 x 122.9	72.9 x 132.9	72.9 x 142.9	62.9 x 132.9	72.9 x 132.9	72.9 x 142.9
Internal box dimensions [cm]		54 x 114	64 x 114	64 x 124	64 x 134	54 x 124	64 x 124	64 x 134
Folded ladder height [cm]	K						27	
Swing space [cm]	R		156				175	
Distance after ladder unfolding [cm]	C		120				135	
Hatch retraction after opening [cm]	P					4		
Box height [cm]						14		

LADDER PARAMETERS

Tread length [cm]	E				34			
Tread width [cm]					8			
Distance between treads [cm]					25			
Tread thickness [cm]					2			

* for rooms lower than the maximum standard height H please adjust the length of the ladder according to the assembly instructions

LOFT LADDER DIMENSIONS

Commercial sizes [cm]		60x120	70x120	70x130	70x140	60x130	70x130	70x140
Room height [cm]	H		280				305	
Code		865701	865711	865712	865713	865751	865753	865754

Ladders are available only in sizes shown above.

WOODEN SECTION LOFT LADDERS

NEW!

LWL
EXTRA

U=0.74
LOFT LADDER
W/m²K

STANDARD
EN 14975

4 CLASS
*
EN12207

LWL Extra wooden loft ladders in new design with **increased insulation parameters**. **LWL Extra** for **increased security** and **comfort of use** has been equipped with an **additional handrail** mounted on the middle folding section and **unloading mechanism** that supports folding and unfolding the ladder.



double system of „seals“ guarantees perfect tightness



Unloading mechanism facilitates folding and unfolding the ladder.



Additional handrail ensures safety and comfort of use.



The hinge controls hatch movement and whilst opening, automatically moves away from the ladder providing added stability and ease of use.



Light hatch weight and method of 'click fixing' makes installation very simple.



Energy-efficient, 5.6cm thick hatch equipped with lock perfectly prevents heat loss.

* manufacturer's internal research



stile ends



easy installation



white hatch



non-slip treads set flush with ladder strings



two seals



ladder unloading mechanism



two handrails



possibility of installing additional accessories pages 54-59

Technical specification:
permissible load 160 kg
loft ladder heat transmission coefficient U=0.74 W/m²K
insulation thickness 5cm
hatch thickness 5.6

fully assembled, and ready for quick installation in the ceiling



3 years WARRANTY

LWL EXTRA LADDER DIAGRAM

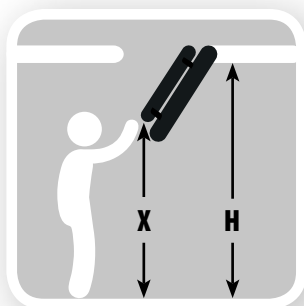

i The LWL Extra ladders are as standard equipped with ladder unloading mechanism, so they can be fully operated with the opening rod.

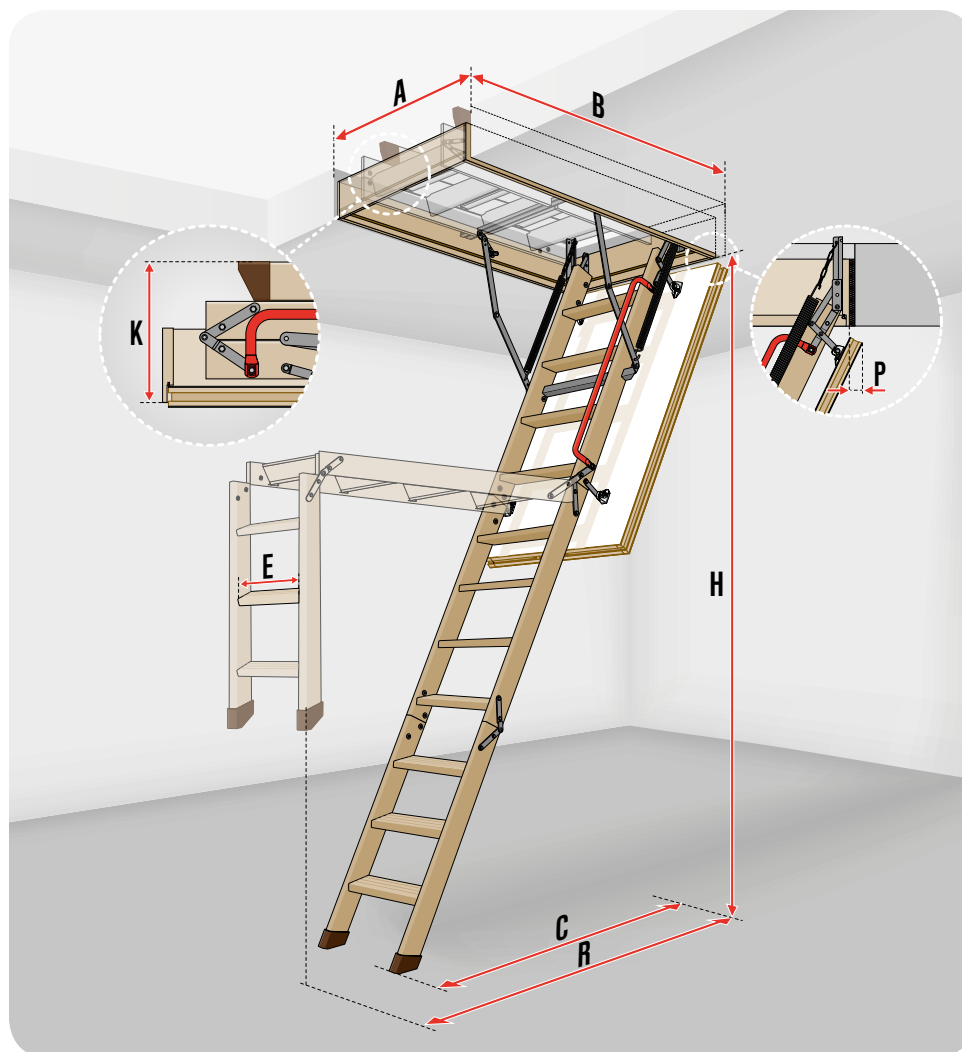

LWL EXTRA LOFT LADDER DIMENSIONS

Ceiling opening dimensions [cm]	AxB	60x120	70x120	70x130	70x140	60x130	70x130	70x140
Maximum room height [cm]	H	280				305		
Minimum room height [cm]*	H _{min.}	260				280		
Height to be reached to operate the ladder [cm]	X	215 i				225 i		
Box external dimensions [cm]		58x118.4	68x118.4	68x128.4	68x138.4	58x128.4	68x128.4	68x138.4
Internal box dimensions [cm]		54x114	64x114	64x124	64x134	54x124	64x124	64x134
Folded ladder height [cm]	K	30						
Hatch retraction after opening [cm]	R	156				175		
Distance after ladder unfolding [cm]	C	120				135		
Box height [cm]		14						
Hatch retraction after opening [cm]		6						

LADDER PARAMETERS

Tread length [cm]	E	30	34		30	34		
Tread width [cm]		8						
Distance between treads [cm]		25						
Tread thickness [cm]		2						

* for rooms lower than the maximum standard height H please adjust the length of the ladder according to the assembly instructions

Commercial sizes [cm]		60x120	70x120	70x130	70x140	60x130	70x130	70x140
Room height [cm]	H	280				305		
Code		867901	867911	867912	867913	867951	867953	867954

Ladders are available only in sizes shown above.

WOODEN
LOFT LADDERS

WOODEN SECTION LOFT LADDERS

LTK
ENERGY

U=0.68
LOFT LADDER
W/m²K

STANDARD
**EN
14975**

4 CLASS
EN12207*

The **LTK Energy** is highly energy efficient new generation loft ladder intended for energy-efficient buildings. They guarantee a high level of comfort, excellent thermal insulation parameters and the highest Class 4 tightness.



Double system of seals guarantees perfect tightness.



CLICK

Light hatch weight and method of 'click fixing' makes installation very simple.



Short distance between the top tread and attic floor.



Highly energy-efficient, 6.6cm thick hatch prevents heat loss, making significant saving on energy bills.



stile ends (only in 3-section version)



white hatch



non-slip treads set flush with ladder strings



two seals



easy installation



handrail



possibility of installing additional accessories pages 54-59

Technical specification:
maximum load of 160 kg
loft ladder heat transmission coefficient U = 0.68 W / m²K
insulation thickness 6 cm
hatch thickness 6.6 cm

fully assembled,
and ready for quick
installation in the ceiling



3 years
WARRANTY

LTK ENERGY LADDER DIAGRAM

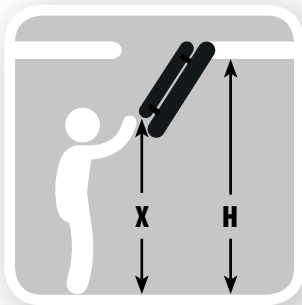

i 3-segment ladder can be equipped with the LXM ladder unloading mechanism (page 58), so that the ladder can be fully operated with a rod

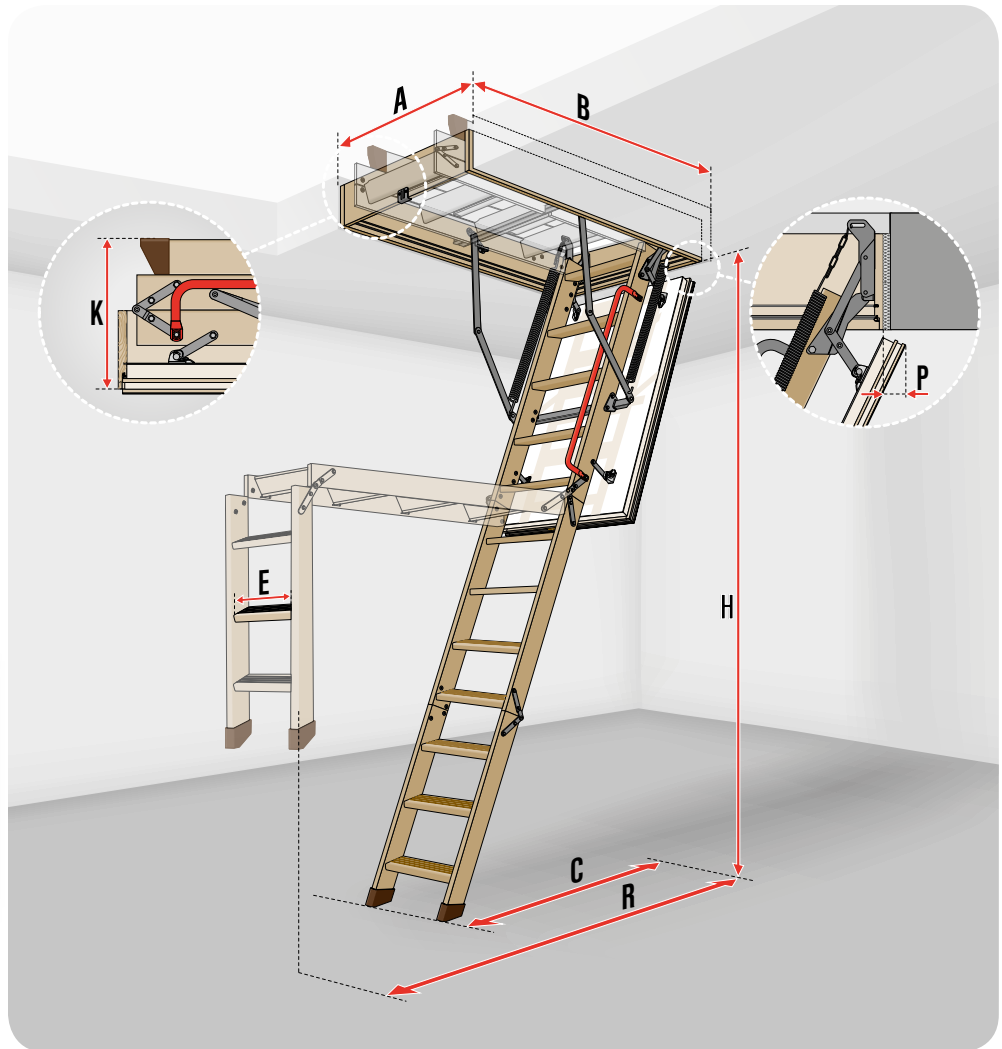

LTK ENERGY LOFT LADDER DIMENSIONS

Ceiling opening dimensions [cm]	A x B	55x100	60x100	70x100	60x120	70x120	70x130	70x140	60x130	70x130	70x140
Maximum room height [cm]	H					280			305		
Minimum room height [cm]*	H _{min.}	253			235			243			
Height to be reached to operate the ladder [cm]	X	230			210 i			230 i			
Box external dimensions [cm]		53x98.4	58x98.4	68x98.4	58x118.4	68x118.4	68x128.4	68x138.4	58x128.4	68x128.4	68x138.4
Internal box dimensions [cm]		49x94	54x94	64x94	54x114	64x114	64x124	64x134	54x124	64x124	64x134
Folded ladder height [cm]	K	42				35					
Swing space [cm]	R	136			164			178			
Distance after ladder unfolding [cm]	C	123			129			139			
Hatch retraction after opening [cm]	P				3						
Box height [cm]					18						
Number of segments		4			3						

LADDER PARAMETERS

Tread length [cm]	E	30				34					
Tread width [cm]					8						
Distance between treads [cm]					25						
Tread thickness [cm]					2						

* for rooms lower than the maximum standard height H please adjust the length of the ladder according to the assembly instructions

LOFT LADDER

Commercial sizes [cm]		55x100	60x100	70x100	60x120	70x120	70x130	70x140	60x130	70x130	70x140	
Room height [cm]	H					280			305			
Code		864720	864706	864716	864701	864711	864712	864713	864751	864753	864754	

Ladders are available only in sizes shown above.

WOODEN
LOFT LADDERS

WOODEN SECTION LOFT LADDERS

LWT

U=0.51
LOFT LADDER
W/m²K

STANDARD
**EN
14975**

4 CLASS
*
EN12207

The highly efficient **LWT** loft ladder is recommended for use in energy-efficient buildings. Its excellent level of insulation significantly reduces heat loss and energy bills.

Triple system of seals guarantees perfect tightness.



Light hatch weight and method of 'click fixing' makes installation very simple.



Short distance between the top tread and attic floor.



Its special 8cm thick hatch is filled with polystyrene insulation to provide an excellent barrier and reduce heat loss.



stile ends (only in 3-section version)



white hatch



non-slip treads set flush with ladder strings



three seals



easy installation



handrail



possibility of installing additional accessories pages 54-59

Technical specification:
permissible load of 160 kg
loft ladder heat transmission coefficient U = 0.51 W / m²K
insulation thickness 7.4 cm
hatch thickness 8 cm

fully assembled,
and ready for quick
installation in the ceiling



3 years
WARRANTY

LWT LOFT LADDER DIAGRAM

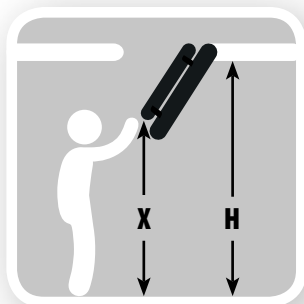

i 3-segment ladder can be equipped with the LXM ladder unloading mechanism (page 58), so that the ladder can be fully operated with a rod

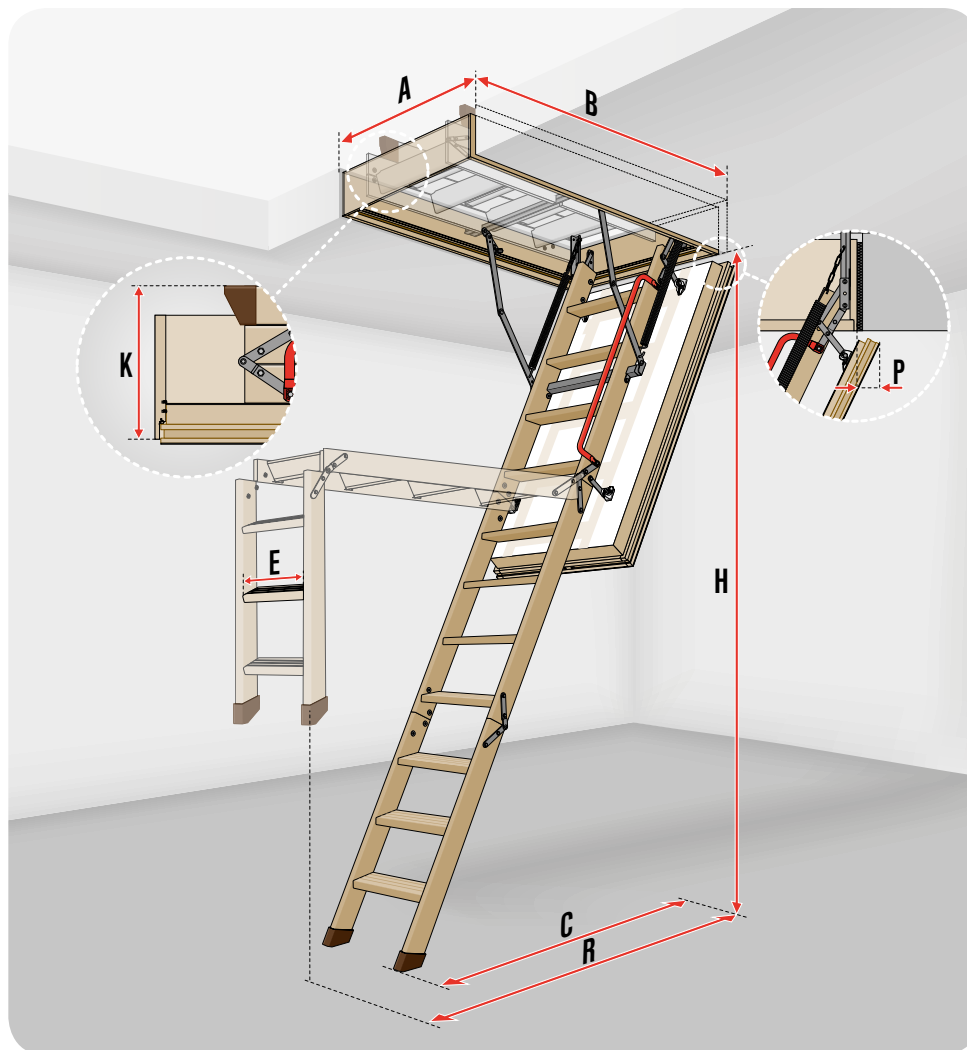

LWT LOFT LADDER DIMENSIONS

Ceiling opening dimensions [cm]	AxB	55x100	60x100	70x100	60x120	70x120	70x130	70x140	60x130	70x130	70x140
Maximum room height [cm]	H	280							305		
Minimum room height [cm]*	H _{min.}	253			234			242			
Height to be reached to operate the ladder [cm]	X	230			210 i			230 i			
Box external dimensions [cm]		53 x 98.4	58 x 98.4	68 x 98.4	58 x 118.4	68 x 118.4	68 x 128.4	68 x 138.4	58 x 128.4	68 x 128.4	68 x 138.4
Internal box dimensions [cm]		49x94	54x94	64x94	54x 114	64x 114	64x 124	64x 134	54x 124	64x 124	64x 134
Folded ladder height [cm]	K	43.5			36			36			
Swing space [cm]	R	136			164			178			
Distance after ladder unfolding [cm]	C	123			130			137			
Hatch retraction after opening [cm]	P				4.5						
Box height [cm]					22						
Number of segments		4			3						

LADDER PARAMETERS

Tread length [cm]	E	30				34					
Tread width [cm]					8						
Distance between treads [cm]					25						
Tread thickness [cm]					2						

* for rooms lower than the maximum standard height H please adjust the length of the ladder according to the assembly instructions

Commercial sizes [cm]		55x100	60x100	70x100	60x120	70x120	70x130	70x140	60x130	70x130	70x140
Room height [cm]	H	280							305		
Code		863120	863106	863116	863101	863111	863112	863113	863151	863153	863154

Ladders are available only in sizes shown above.

WOODEN
LOFT LADDERS



LOFT LADDERS WITH WOODEN FOLDING SECTION

LWT
PASSIVE
HOUSE

U=0.51
LOFT LADDER
W/m²K

STANDARD
**EN
14975**

4 CLASS
EN12207*



The **LWT Passive House** loft ladder is a technically complex design specifically developed for the demands of such energy-efficient construction standards. It is installed with a kit which connects the ladder to the ceiling to guarantee a perfect seal and insulation without thermal bridges. It comes with Passive House certification.

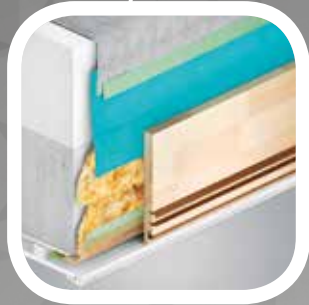

Kit allows for proper loft ladder insulation in the ceiling.



Short distance between the top tread and attic floor.



Triple system of seals guarantees perfect tightness.



Its special 8cm thick hatch is filled with polystyrene insulation to provide an excellent barrier and reduce heat loss.



stile ends



PASSIVE HOUSE
Insulation kit



white hatch



non-slip treads set flush
with ladder strings



three seals
x3



easy installation



handrail



possibility of installing
additional accessories
pages 54-59

Technical specification:
permissible load of 160 kg
loft ladder heat transmission coefficient U = 0.51 W / m²K
insulation thickness 7.4 cm
hatch thickness 8 cm

fully assembled,
and ready for quick
installation in the ceiling



LWT PASSIVE HOUSE HOUSE LOFT LADDER DIAGRAM

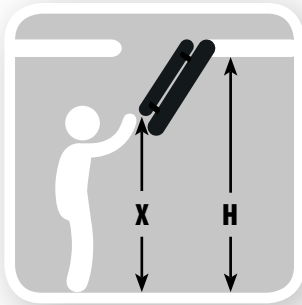

i 3-segment ladder can be equipped with the LXM ladder unloading mechanism (page 58), so that the ladder can be fully operated with a rod

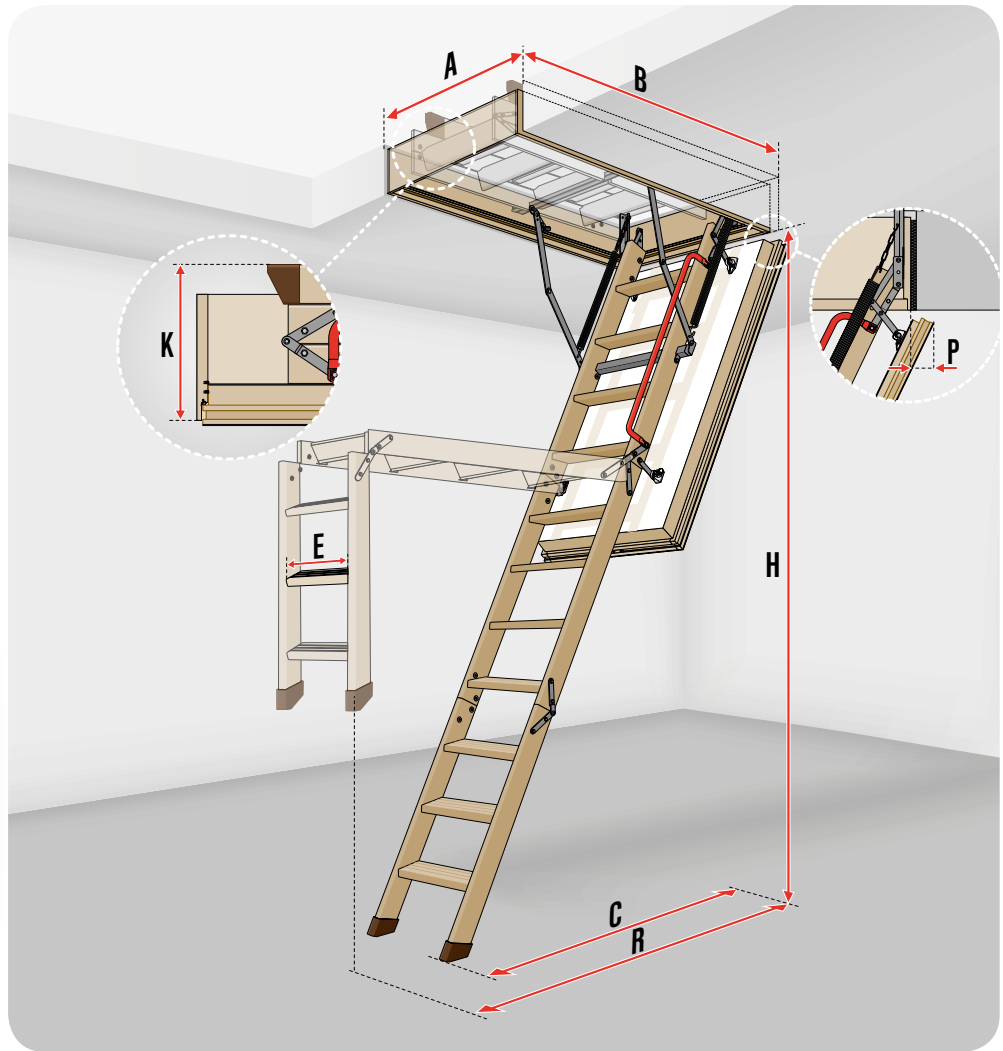

LWT PASSIVE HOUSE LOFT LADDER DIMENSIONS

Ceiling opening dimensions [cm]	AxB	62x122	72x122	72x132	72x142	62x132	72x132	72x142	
Maximum room height [cm]	H		280			305			
Minimum room height [cm]*	H _{min.}		234			242			
Height to be reached to operate the ladder [cm]	X		210 i			230 i			
Box external dimensions [cm]		58x118.4	68x118.4	68x128.4	68x138.4	58x128.4	68x128.4	68x138.4	
Internal box dimensions [cm]		54x114	64x114	64x124	64x134	54x124	64x124	64x134	
Folded ladder height [cm]	K	36							
Swing space [cm]	R	164			178				
Distance after ladder unfolding [cm]	C	127			137				
Hatch retraction after opening [cm]	P					4.5			
Box height [cm]		22							

LADDER PARAMETERS

Tread length [cm]	E	34						
Tread width [cm]		8						
Distance between treads [cm]		25						
Tread thickness [cm]		2						

* for rooms lower than the maximum standard height H please adjust the length of the ladder according to the assembly instructions

LOFT LADDER

Commercial sizes [cm]		62x122	72x122	72x132	72x142	62x132	72x132	72x142	
Room height [cm]	H	280				305			
Code		8665AE	8665AF	8665AG	8665AH	8665AJ	8665AK	8665AL	

Ladders are available only in sizes shown above.

WOODEN
LOFT LADDERS



LOFT LADDERS WITH WOODEN FOLDING SECTION

NEW!

LWF 60
FIRE-RESISTANT

U=0.64*
LOFT LADDER
W/m²K

STANDARD
EN 14975

EN 13501-2
EI, 60



The **LWF60**, a new generation of fire resistant loft ladders with wooden ladder which perfectly combines a **high level of fire protection** with comfortable and safe access to the loft. Special hatch design and materials used provide a 60-minute protection against fire penetration from the space where the loft ladder was installed. Fire resistance class **EI₁ 60/EI₂ 60**, classification according to EN 13501.



Triple system of seals guarantees perfect airtightness.



Short distance between the top tread and loft floor.



The hinge controls hatch movement, and as its opened, moves the hatch away from the ladder's treads. Resulting in increased space and easy operation.



Insulated and finished in white on both sides, the hatch is also equipped with an expandable seal. When this seal is exposed to high temperatures, it expands and prevents fire from breaching the hatch.

* manufacturer's internal research



stile ends (only in 3-section version)



handrail



fire resistant hatch on one side



non-slip treads set flush with ladder strings



three seals x3



possibility of installing additional accessories pages 54-59

Technical specification:
maximum load of 160 kg
loft ladder heat transmission coefficient U = 0.64 W/m²K
Fire resistance class EI₁/EI₂ = 60 minutes
insulation thickness 7.9 cm
hatch thickness 8.5 cm

fully assembled,
and ready for quick
installation in the ceiling



3 years
WARRANTY

LWF 60 LOFT LADDER DIAGRAM

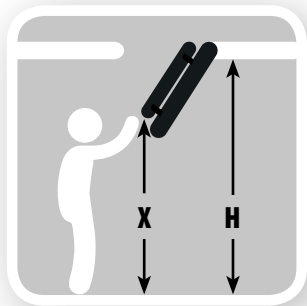

i 3-segment ladder can be equipped with the LXM ladder unloading mechanism (page 58), so that the ladder can be fully operated with a rod

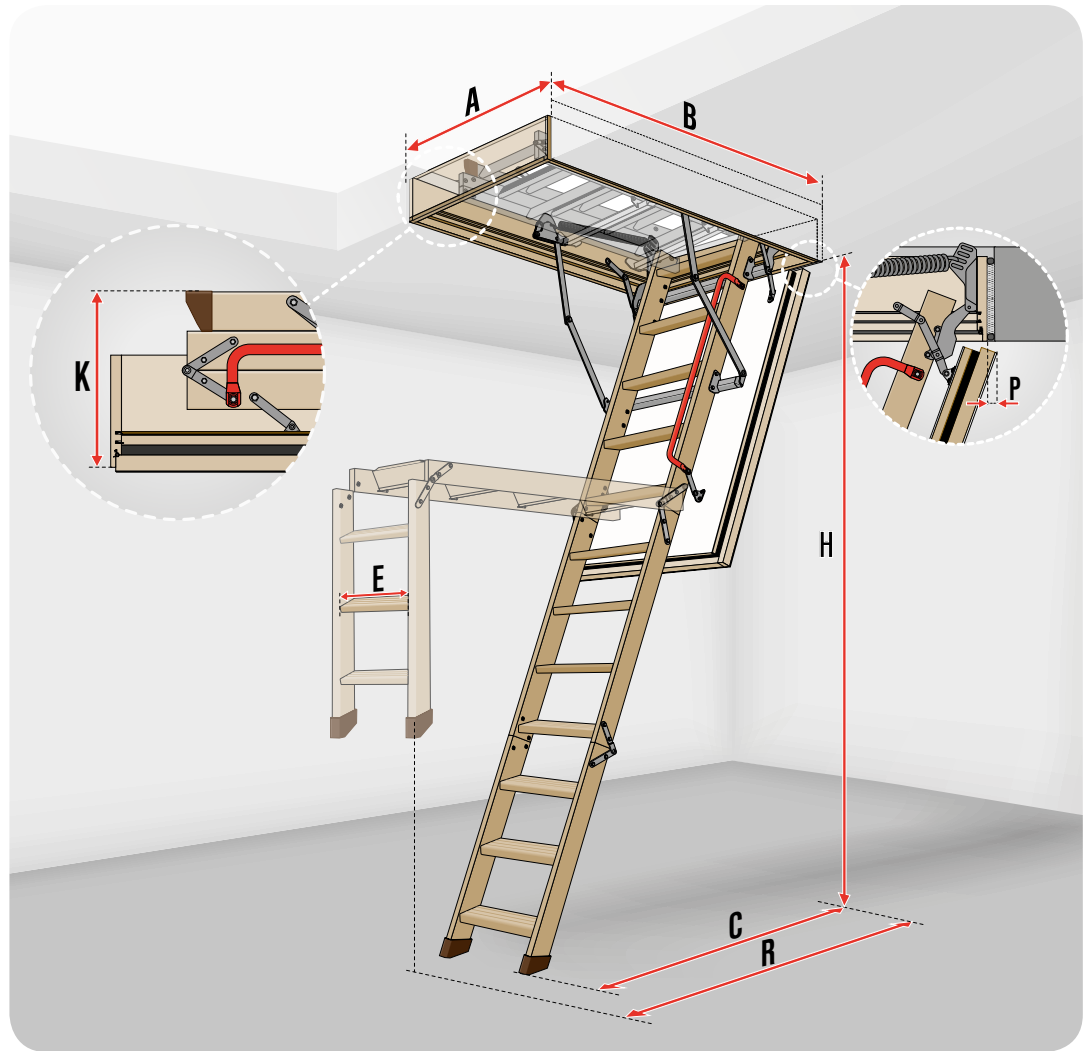

LWF 60 LOFT LADDER DIMENSIONS

Ceiling opening dimensions [cm]	AxB	55x100	55x120	60x100	70x100	60x120	70x120	70x130	70x140	86x130	55x130	70x130	70x140	86x130	
Maximum room height [cm]	H	280										305			
Minimum room height [cm]*	H _{min.}	253				234				242					
Height to be reached to operate the ladder [cm]	X	235				210				230					
Box external dimensions [cm]		53x98	53x118	58x98	68x98	58x118	68x118	68x128	68x138	84x128	53x128	68x128	68x138	84x128	
Internal box dimensions [cm]		49x94	49x114	54x94	64x94	54x114	64x114	64x124	64x134	80x124	49x124	64x124	64x134	80x124	
Folded ladder height [cm]	K	46								38					
Swing space [cm]	R	138				164				178					
Distance after ladder unfolding [cm]	C	126				129				139					
Hatch retraction after opening [cm]	P									5					
Box height [cm]										22.5					
Number of segments		4								3					

LADDER PARAMETERS

Tread length [cm]	E	30				34				30				34			
Tread width [cm]										8							
Distance between treads [cm]										25							
Tread thickness [cm]										2							

* for rooms lower than the maximum standard height H please adjust the length of the ladder according to the assembly instructions

Commercial sizes [cm]		55x100	55x120	60x100	70x100	60x120	70x120	70x130	70x140	86x130	55x130	70x130	70x140	86x130	
Room height [cm]	H	280										305			
Code		869G20	869G22	869G06	869G16	869G01	869G11	869G12	869G13	869G96	869G57	869G53	869G54	869G97	

Ladders are available only in sizes shown above.

WOODEN
LOFT LADDERS



SLIDING SECTION LOFT LADDERS

LDK

U=1.1
HATCH
W/m²K

STANDARD
**EN
14975**

The **LDK** loft ladder is a 2-section, sliding loft ladder. It is similar in style to folding section ladders, the main difference being that the bottom section simply slides up into the loft, eliminating the need for swing space.



The sliding ladder mechanism has a longer lower section which gives it stability.



white hatch



peripheral seal



handrail



non-slip treads with additional depth



possibility of installing additional accessories pages 54-59

Technical specification:
maximum load of 160 kg
hatch heat transmission coefficient U = 1.1 W/m²K
insulation thickness 3 cm
hatch thickness 3.6 cm

fully assembled,
and ready for quick
installation in the ceiling



3 years
WARRANTY

LDK LOFT LADDER DIAGRAM

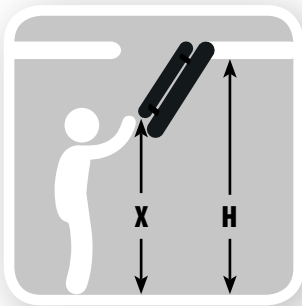
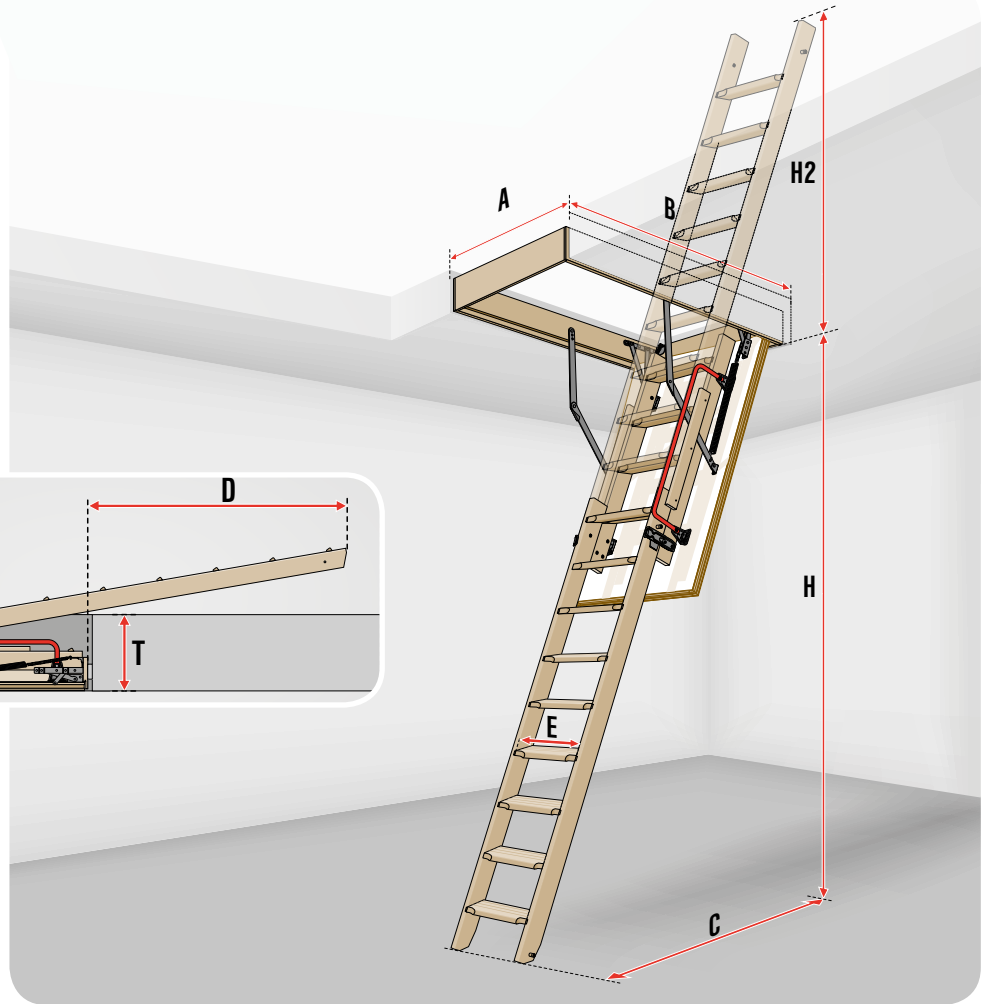
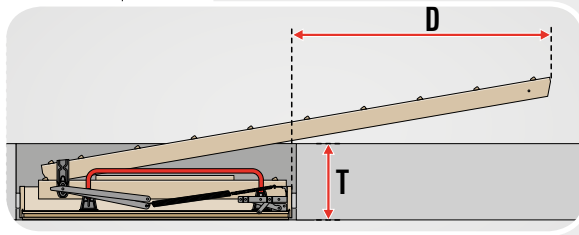

LDK LADDER DIMENSIONS

Ceiling opening dimensions [cm]	AxB	60x120	70x120	70x130	70x140	60x120	70x120	70x130	70x140
Sliding section LDS		LDS-9				LDS-10			
Maximum room height [cm]	H	280				305			
Minimum room height [cm]*	H _{min.}	200							
Height to be reached to operate the ladder [cm]	X	210				230			
Box external dimensions [cm]		58x118.4	68x118.4	68x128.4	68x138.4	58x118.4	68x118.4	68x128.4	68x138.4
Internal dimensions of the box [cm]		54x114	64x114	64x124	64x134	54x114	64x114	64x124	64x134
Distance of drop [cm]	C	130				140			
Max height of the loft required [cm]	H2	130				155			
Max length of the loft required with hatch door closed	D	129				155			
Max thickness of the ceiling [cm]	T					35			
Box height [cm]						14			

LADDER PARAMETERS

Tread length [cm]	E	34							
Tread width [cm]		8							
Distance between treads [cm]		25							
Tread thickness [cm]		2							

* for rooms lower than the maximum standard height H please adjust the length of the ladder according to the assembly instructions

LOFT LADDER

Commercial sizes [cm]		60x120	70x120	70x130	70x140	60x120	70x120	70x130	70x140
Room height [cm]	H	280				305			
Code LDK*		861001	861011	861012	861013	861001	861011	861012	861013
Code LDS*		861101	861101	861101	861101	861102	861102	861102	861102

* The LDK complete ladder consists of the top element and sliding section LDS, packed separately.

NON-STANDARD LOFT LADDER SIZES

NON-STANDARD LOFT LADDER SIZES

Where installation of a standard FAKRO loft ladder is not possible, bespoke timber folding sections of the LWK KOMFORT can be made.

▶ BOX

The loft ladder box is made of wood and has a peripheral seal placed within a milled recess. Once the hatch is closed, this seal ensures full airtightness is provided and once installed the box's special design enables quick and easy fitting of either a lining or architrave.

▶ HARDWARE

The spring catch provides added rigidity to the box, prevents distortion and ensures that the ladder will continue to be operated trouble-free. The hinges joining each section of the ladder also add strength to connections as they move.

▶ TREADS

Grooves which are cut into the tread surface protect the user from accidental slipping while using the ladder.

▶ STILE ENDS

Stile ends (for 3-section loft ladders only) made of PVC protect the floor surface from scratching and add to overall stability.

▶ HATCH OPENING MECHANISM

Operation of the loft ladder is significantly improved because of Fakro's unique unloading mechanism. Once unlocked, the hatch opens slowly without any potential danger to the user. Once fully opened, this mechanism will also hold the hatch in position, preventing it from slamming shut.

▶ HATCH

The loft ladder hatch is made of wood and can be either insulated or fire-resistant. The insulation protects against heat loss while fire-resistant material protects against heat build-up caused by spread of flame. The external hatch surface is smooth with no visible fixing points to detract from the visual style of any interior design.

▶ LADDER

FAKRO loft ladders are predominantly of three sections, though some have four. These are moved away from the hatch in order to create more space for the feet. The special ladder structure and materials used ensure the highest standard of durability.



When ordering the **LWK Komfort** loft ladder in non-standard sizes the actual dimensions of the ceiling opening ('A' and 'B') and the room height 'H' have to be provided.

The actual size of the loft ladder box is reduced (for installation reasons) by 2 cm in width and 1.6 cm in length, e.g. for the opening dimensions 54 x 94cm, those of the ladder would be 52 x 92.4cm. When ordering please take into account the swing space needed when unfolding (swing space 'R'), the distance once the ladder is unfolded (distance 'C') and hatch retraction after it is opened (distance 'P').

LWK Komfort loft ladders are equipped with a hatch which is finished in white on both sides (three section ladders only), and, with the exception of ladders for a 54cm hatch width, a handrail. The height of the loft ladder box is 14cm though to provide a neat finish with deeper ceilings an LXN box extension can be installed (see page 56).

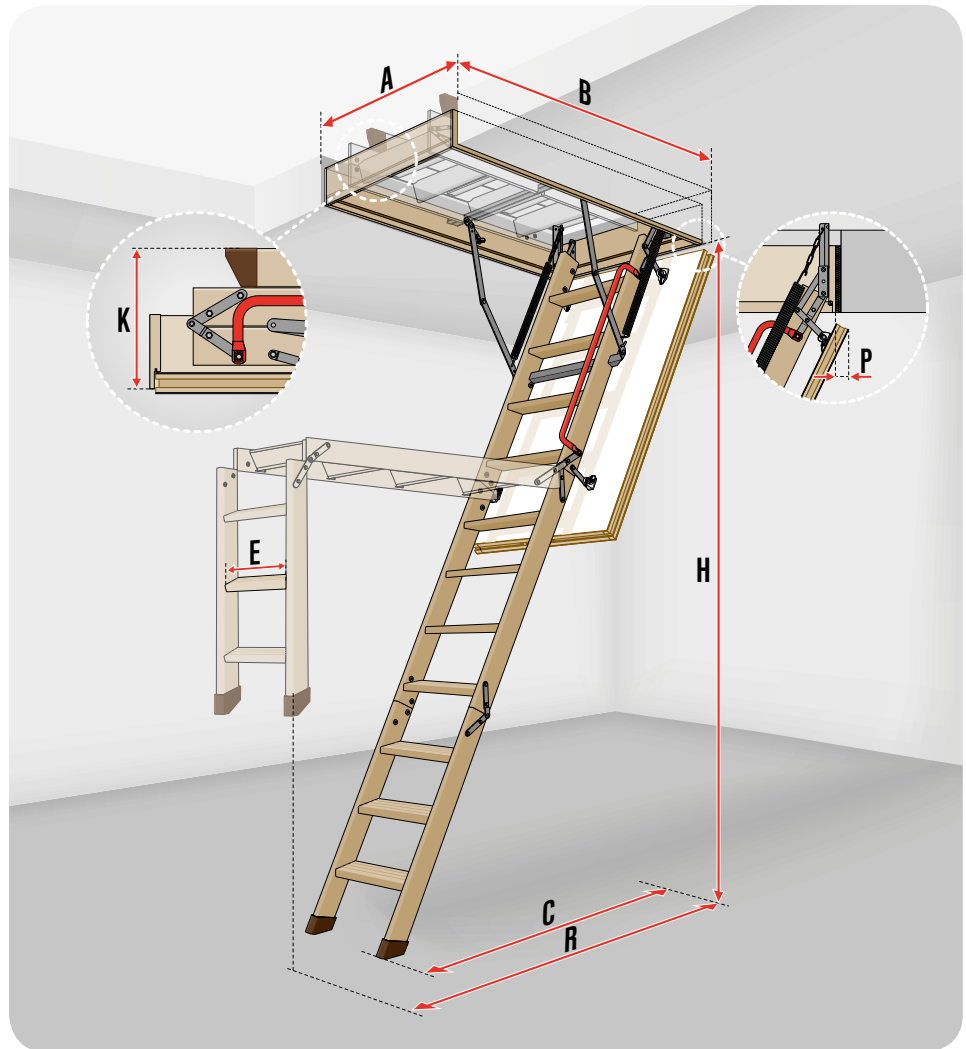

LOFT LADDER COMMERCIAL SIZES

Ceiling opening width [cm]	Ceiling opening length [cm]	Room height [cm]	Swing space (measured from the rear edge of the box) [cm]	Distance after ladder unfolding (measured from the rear edge of the box) [cm]	Hatch retraction after opening [cm]	Number of segments after opening
A	B	H	R	C	P	
54-86	94-140	200-280	115-155	89-120	4	3 or 4 segments*
	120-129	280-305	140	110-119	4	4 segments
	130-140	280-305	155-175	120-135	4	3 segments
	140	305-335	175-184	135-146	4	3 segments

* - Number of ladder's segments depends on the opening length configuration and room height.

TREAD LENGTH:

3-segment ladder

Ceiling opening width A [cm]	54 ≤ A < 58	58 ≤ A
Tread length E [cm]	30	34

4-segment ladder

Ceiling opening width A [cm]	54 ≤ A < 56	56 ≤ A < 60	60 ≤ A
Tread length E [cm]	28	30	34

METAL SECTION
LOFT LADDERS



SECTION
LOFT LADDERS



► BOX

The ladder box can be of wood, metal or a combination of a wooden box / metal frame. It has been designed to enable architrave to be installed with ease if the ready-fitted option is not chosen. Peripheral single or double seals provide a good standard of airtightness.

► HATCH UNFOLDING MECHANISM

The hatch opening mechanism enables it to be fully or partly open positions to ensure folding and unfolding are done in safety. LML and LMF loft ladders also have a hidden mechanism in the handrail which in conjunction with that of the hatch opening enables them to be opened or closed with a single rod.

► HARDWARE

The patented corner hinge design adds rigidity to the box and prevents distortion. This ensures that the ladder will continue to be operated trouble-free.

► HATCH

The loft ladder hatch is made of wood or metal and can be either insulated or fire-resistant. The insulation protects against heat loss while fire-resistant material protects against heat build-up caused by spread of flame. The external hatch surface is smooth to blend effectively with the visual style of any interior design.

► TREAD

Circular embossing of the tread surface prevents slipping while the width of treads (8 or 13cm) enables them to be used safely and with ease.

► LADDER

The special design of the metal ladder and a double connection of the ladder hinges guarantee high ladder strength. Ladder elements are powder-coated with hard wearing lacquer in grey RAL 7022 or silver RAL 9006. Some metal ladders have the final two treads left loose and with telescopic stile ends this enables adjustments of the ladder length to be made without the need for cutting.

► STILE ENDS

Made from plastic, these protect the floor from scratches and in addition add to the overall ladder stability.

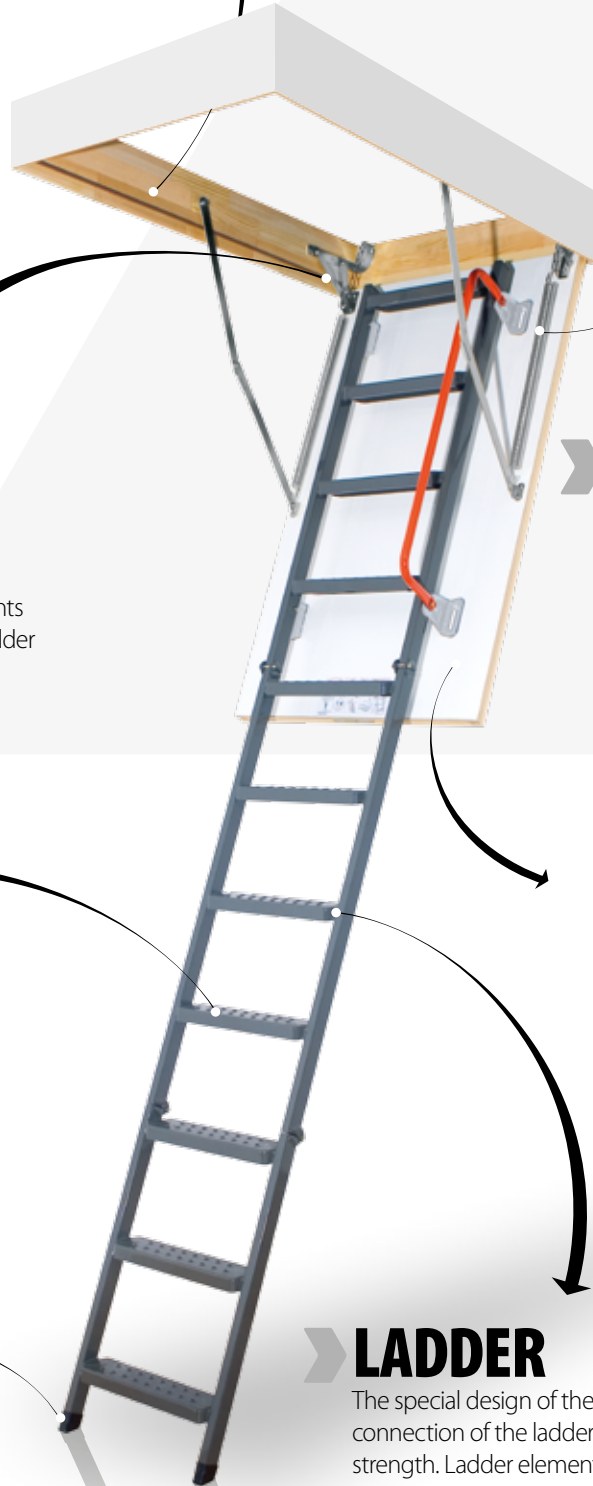

METAL
LOFT LADDERS



METAL FOLDING SECTION LOFT LADDERS

LMS
SMART



▶ The **LMS** is a 3-section loft ladder in which the hatch and box are made of pine. The metal ladder is powder-coated in RAL 7022 while the insulated hatch is finished in beige.



The use of metal ladder with special hinge structure guarantees high durability -permissible loading 200kg.



stile ends



beige hatch



non-slip treads



peripheral seal



possibility of installing additional accessories pages 54-59

Technical specification:
permissible loading of 200 kg
hatch heat transmission coefficient $U = 1.1 \text{ W/m}^2\text{K}$
insulation thickness 3 cm
hatch thickness 3.6 cm

fully assembled,
and ready for quick
installation in the ceiling



LMS LOFT LADDER DIAGRAM

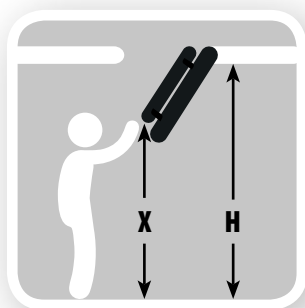
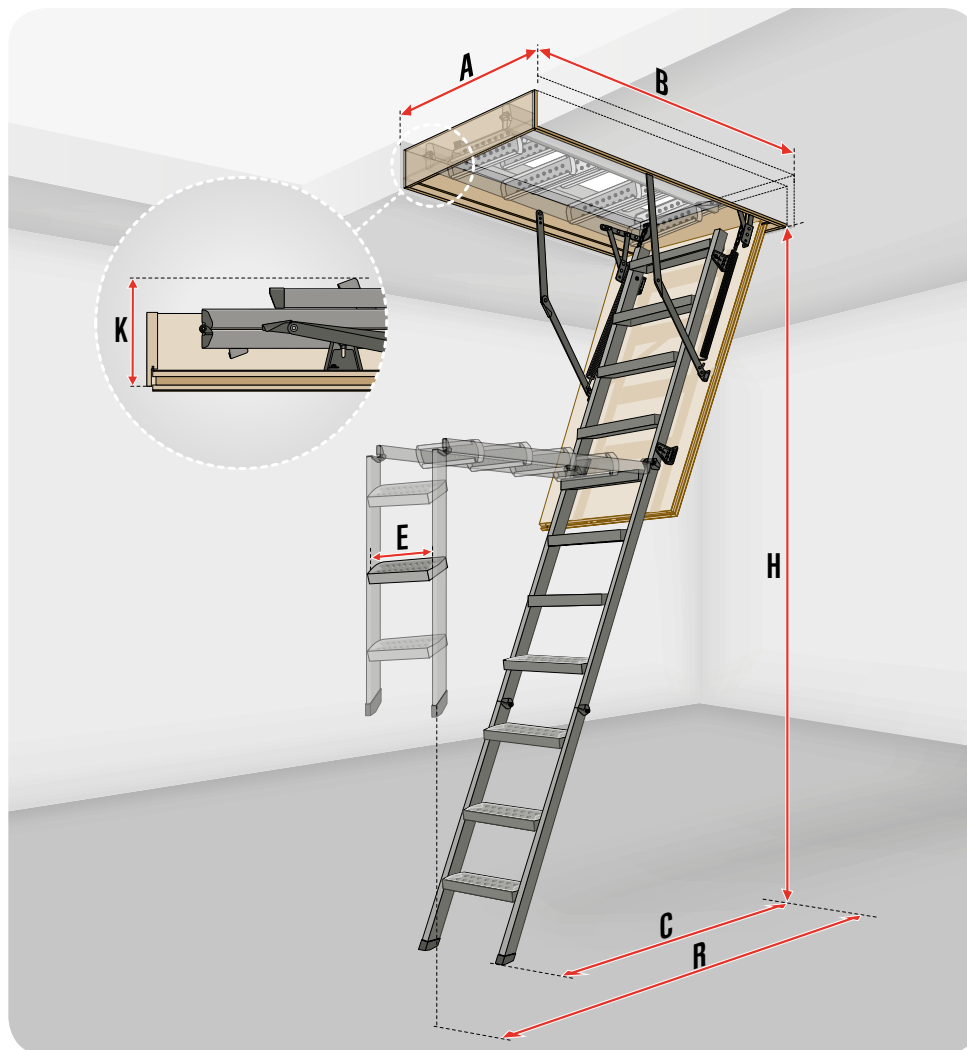

LMS LOFT LADDER DIMENSIONS



Ceiling opening dimensions [cm]	AxB	60x120	70x120
Maximum room height [cm]	H	280	
Minimum room height [cm]*	H _{min.}	220	
Height to be reached to operate the ladder [cm]	X	220	
Box external dimensions [cm]		58 x 118.4	68 x 118.4
Internal box dimensions [cm]		54 x 114	64 x 114
Folded ladder height [cm]	K	25.5	
Swing space [cm]	R	157	
Distance after ladder unfolding [cm]	C	118.5	
Box height [cm]		14	

LADDER PARAMETERS

Tread length [cm]	E	34
Tread width [cm]		8
Distance between treads [cm]		25

* for rooms lower than the maximum standard height H please adjust the length of the ladder according to the assembly instructions

LOFT LADDER

Commercial sizes [cm]		60x120	70x120
			
Room height [cm]	H	280	
Code		861201	861211

Ladders are available only in sizes shown above.

METAL
LOFT LADDERS



METAL FOLDING SECTION LOFT LADDERS

LMK
KOMFORT

U=1.1
HATCH
W/m²K

STANDARD
EN
14975

Unlike the LMS the **LMK** loft ladder has a white hatch and red handrail. The handrail is fixed to the ladder brackets, making its use much easier.



White insulated hatch and handrail



stile ends



handrail



white hatch



non-slip treads



peripheral seal



possibility of installing additional accessories pages 54-59

Technical specification:
permissible loading of 200 kg
hatch heat transmission coefficient U = 1.1 W/m²K
insulation thickness 3 cm
hatch thickness 3.6 cm

fully assembled,
and ready for quick
installation in the ceiling



3 years
WARRANTY

LMK LOFT LADDER DIAGRAM

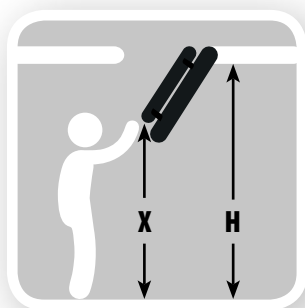
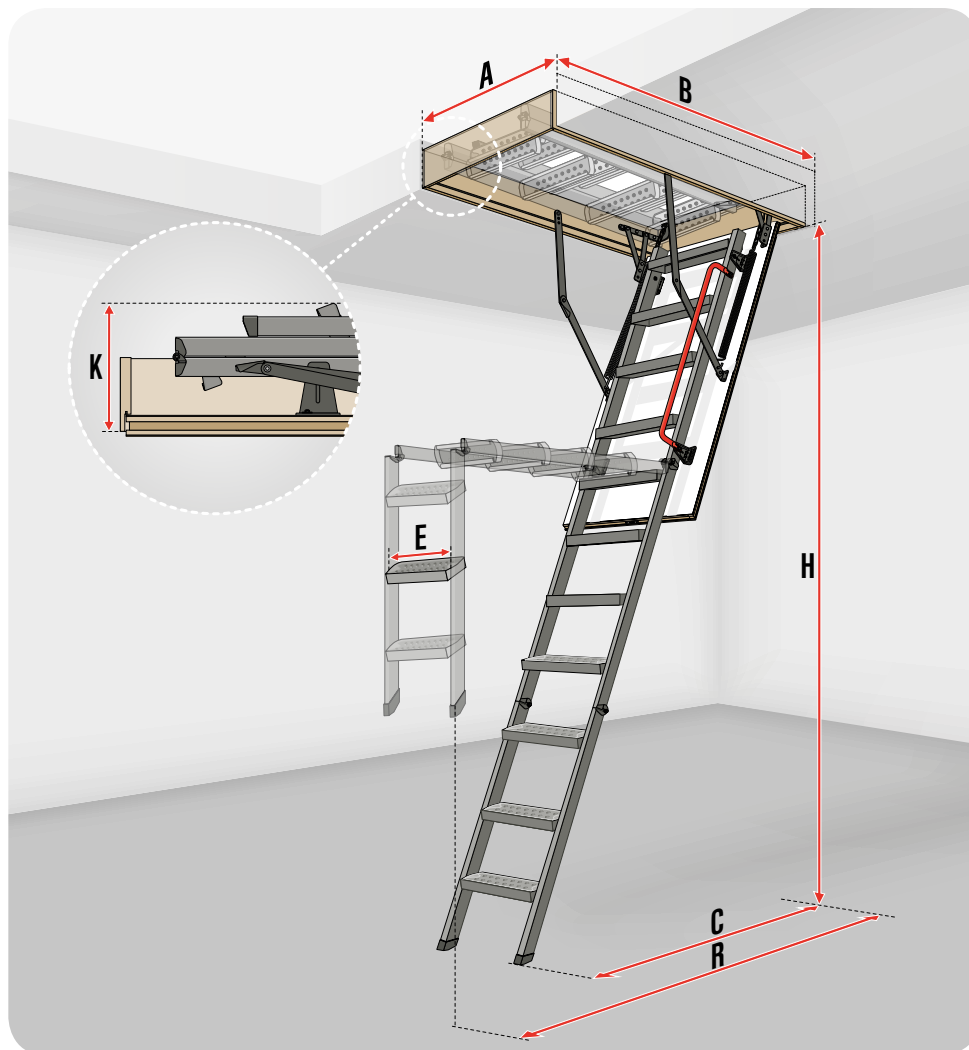

LMK LOFT LADDER DIMENSIONS

Ceiling opening dimensions [cm]	AxB	60x120	70x120	70x130	70x140	60x130	70x130	70x140
Maximum room height [cm]	H			280				305
Minimum room height [cm]*	H _{min.}			220				245
Height to be reached to operate the ladder [cm]	X			220				245
Box external dimensions [cm]		58 x 118.4	68 x 118.4	68 x 128.4	68 x 138.4	68 x 128.4	68 x 128.4	68 x 138.4
Internal box dimensions [cm]		54 x 114	64 x 114	64 x 124	64 x 134	54 x 124	64 x 124	64 x 134
Folded ladder height [cm]	K			25.5				
Swing space [cm]	R			157			175	
Distance after ladder unfolding [cm]	C			118.5			127	
Box height [cm]				14				

LADDER PARAMETERS

Tread length [cm]	E				34			
Tread width [cm]					8			
Distance between treads [cm]					25			

* for rooms lower than the maximum standard height H please adjust the length of the ladder according to the assembly instructions

LOFT LADDER

Commercial sizes [cm]		60x120	70x120	70x130	70x140	60x130	70x130	70x140
Room height [cm]	H			280			305	
Code		861401	861411	861412	861413	861451	861453	861454

Ladders are available only in sizes shown above.

METAL
LOFT LADDERS



METAL FOLDING SECTION LOFT LADDERS

LML
LUX



Steel frame integrated with a wooden box, metal architrave lining and quick fit brackets.



Mechanism hidden within the rail aids folding and unfolding of the ladder.



Additional tread shortens distance between top tread and loft floor.



Telescopic stile ends enable quick adjustment of ladder length to suit ceiling height.

U=1.1
HATCH
W/m²K

STANDARD
EN
14975

The **LML** folding section metal loft ladder has been designed to provide the highest standard of ease and convenience while offering simple assembly and height adjustment.



telescopic stile ends



ladder unloading mechanism built in handrail



white hatch



system of quick installation in the ceiling



finishing lining slats



non-slip treads, 13cm in width



peripheral seal



possibility of installing additional accessories pages 54-59

Technical specification:
permissible loading of 200 kg
hatch heat transmission coefficient U = 1.1 W/m²K
insulation thickness 3 cm
hatch thickness 3.6 cm

fully assembled,
and ready for quick
installation in the ceiling



LML LUX LOFT LADDER DIAGRAM

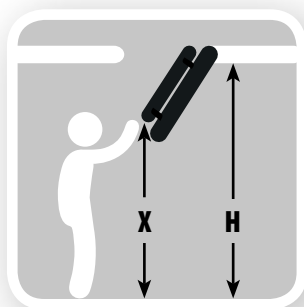

i The LML ladders as standard are equipped with ladder unloading mechanism, so they can be fully operated with the opening rod (hatch opening and closing, ladder unfolding).

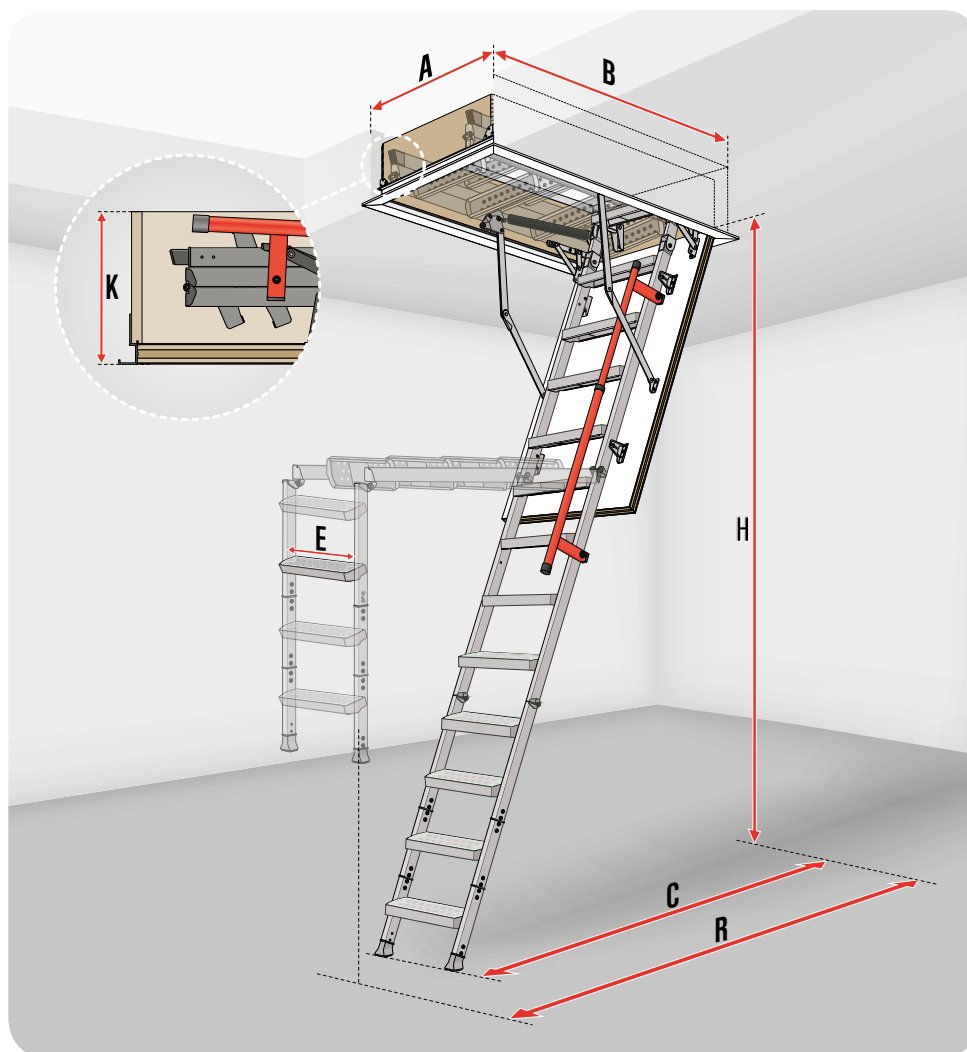

LML LUX LOFT LADDER DIMENSIONS

Ceiling opening dimensions [cm]	AxB	60x120	70x120	70x130	70x140	86x130	92x130	60x130	70x130	70x140	86x130	92x130
Maximum room height [cm]	H				280					305		
Minimum room height [cm]*	H _{min.}				233					256		
Height to be reached to operate the ladder [cm]	i X				205					230		
Box external dimensions [cm]		59.6x118.6	68.6x118.6	68.6x128.6	68.6x138.6	84.6x128.6	90.6x128.6	59.6x128.6	68.6x128.6	68.6x138.6	84.6x128.6	90.6x128.6
Box external dimensions with architrave linings [cm]		63.6x122.6	72.6x122.6	72.6x132.6	72.6x142.6	88.6x132.6	94.6x132.6	63.6x132.6	72.6x132.6	72.6x142.6	88.6x132.6	94.6x132.6
Internal box dimensions [cm]		54.7x113.7	63.7x113.7	63.7x123.7	63.7x133.7	79.7x123.7	85.7x123.7	54.7x123.7	63.7x123.7	63.7x133.7	79.7x123.7	85.7x123.7
Folded ladder height [cm]	K						31.5					
Swing space [cm]	R				167					178		
Distance after ladder unfolding [cm]	C				120					130		
Box height [cm]							31.5					

LADDER PARAMETERS

Tread length [cm]	E						35					
Tread width [cm]							13					
Distance between treads [cm]							25					

* for rooms lower than the maximum standard height H please adjust the length of the ladder according to the assembly instructions

LOFT LADDER

Commercial sizes [cm]		60x120	70x120	70x130	70x140	86x130	92x130	60x130	70x130	70x140	86x130	92x130
Room height [cm]	H				280					305		
Code		862401	862411	862412	862413	862496	862498	862451	862453	862454	862497	862499

Ladders are available only in sizes shown above.

METAL LOFT
LADDERS

METAL FOLDING SECTION LOFT LADDERS

LMP



White on both sides, 3.6 cm thick, insulated hatch equipped with a latch



Added safety, thanks to lock which prevents against unintentional folding.



Short distance between the last tread and attic floor enhances the comfort of use.



Ladders intended for installation in high ceiling rooms.

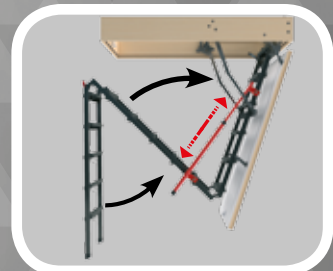

Insulated and finished in white on both sides, the hatch is also equipped with an expandable seal. When this seal is exposed to high temperatures, it expands and prevents fire from breaching the hatch.

U=1.1
HATCH
W/m²K

STANDARD
EN 14975

The LMP new generation loft ladder, allows access to attic space, even in very high ceiling rooms (from 300 to 366cm). The unloading system used in ladder allows for convenient operation while maintaining the maximum comfort and safety of use.



stile ends



ladder unloading mechanism built in handrail



white hatch



non-slip treads



peripheral seal



possibility of installing additional accessories pages 54-59



for high rooms

Technical specification:
permissible loading of 200 kg
hatch heat transmission coefficient $U = 1.1 \text{ W/m}^2\text{K}$
insulation thickness 3 cm
hatch thickness 3.6 cm

fully assembled,
and ready for quick
installation in the ceiling



3 years
WARRANTY

LMP LOFT LADDER DIAGRAM

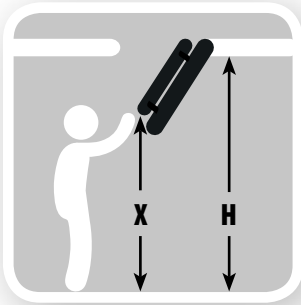
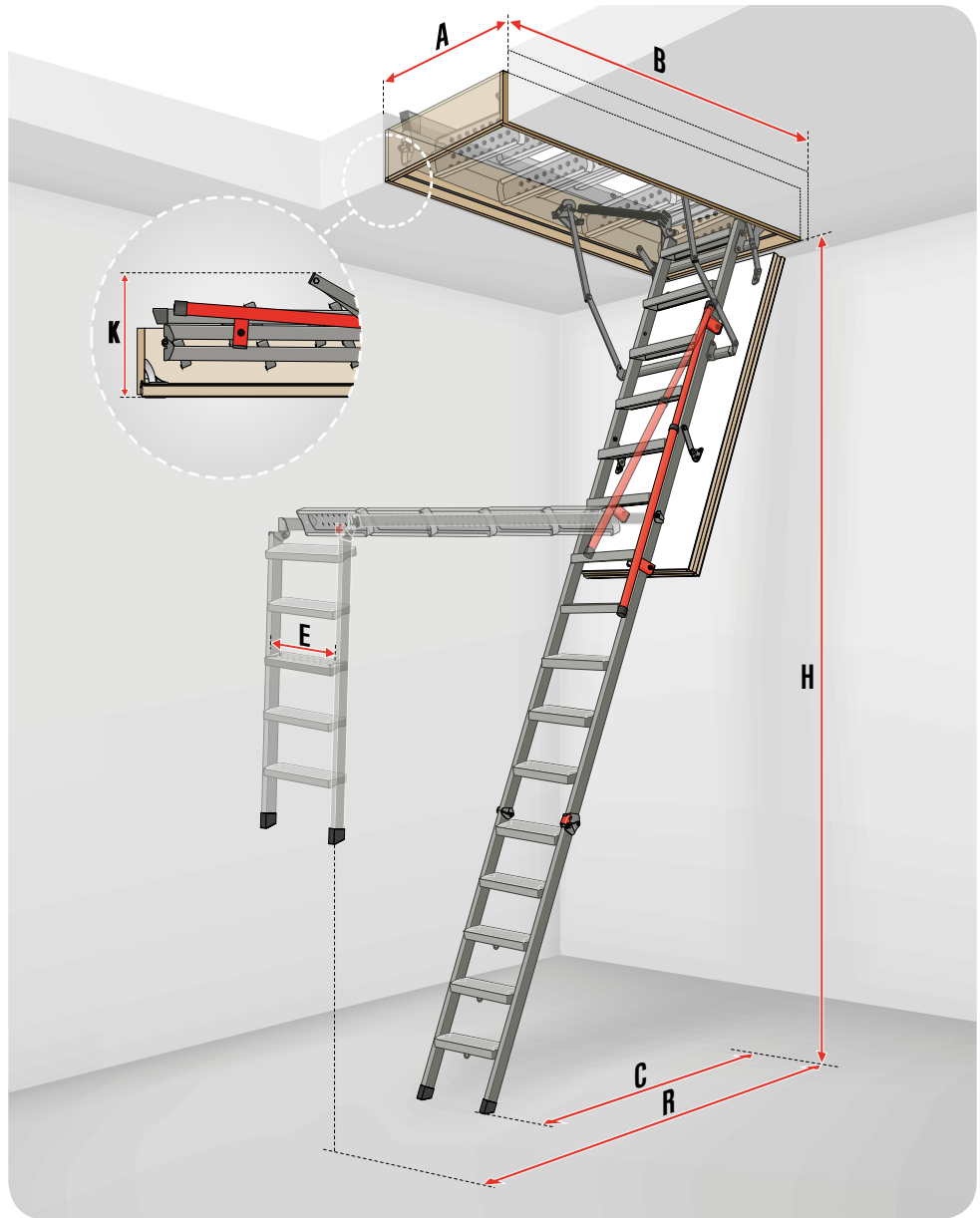

i The LMP ladders as standard are equipped with ladder unloading mechanism, so they can be fully operated with the opening rod (hatch opening and closing, ladder unfolding).

LMP LOFT LADDER DIMENSIONS

Ceiling opening dimensions [cm]	AxB	60x144	70x144	86x144
Maximum room height [cm]	H		366	
Minimum room height [cm]*	H _{min.}		300	
Height to be reached to operate the ladder [cm]	X		270	
Box external dimensions [cm]	WxL	58x142.2	68x142.2	84x142.2
Internal box dimensions [cm]	MxN	54x138.2	64x138.2	80x138.2
Folded ladder height [cm]	K		32	
Swing space [cm]	R		196	
Distance after ladder unfolding [cm]	C		145	
Box height [cm]			18	

LADDER PARAMETERS

Tread length [cm]	E		34	
Tread width [cm]	S		8	
Distance between treads [cm]	G		24	

* for rooms lower than the maximum standard height H please adjust the length of the ladder according to the assembly instructions

LOFT LADDER

Commercial sizes [cm]		60x144	70x144	86x144
Room height [cm]	H		366	
Code		869334	869335	869336

Ladders are available only in sizes shown above.

METAL LOFT
LADDERS

METAL FOLDING SECTION LOFT LADDERS

NEW!

LMF 60
FIRE-RESISTANT

U=0.64
LOFT LADDER
W/m²K

STANDARD
EN 14975

EN 13501-2
E₁ **60**



Triple system of seals
guarantees perfect
tightness.



only in loft
ladders to room
height 360cm



Short distance between the
last tread and attic floor.



The hinge controls hatch
movement, and as its
opened, moves the hatch
away from the ladder's
treads. Resulting in
increased space and easy
operation.



The white on both sides and insulated,
the hatch is equipped with expandable
seal which under the influence of heat
expands and prevents entering the fire to
the fire free space.

The LMF 60 to room height 360cm
as standard are equipped with ladder
unloading mechanism, so they can be
fully operated with the opening rod (hatch
opening and closing, ladder unfolding).

The LMF 60 a new generation of fire
resistant loft ladders with metal ladder
which perfectly combines a high level
of fire protection with comfortable and
safe access to the loft. The materials
used provide 60-minute protection against
fire penetration from the space where
the loft ladder was installed.

*manufacturer's internal research



stile ends



ladder unloading
mechanism built in handrail
(in version 360cm in height).



one - sidedly
fire-resistant hatch



non-slip treads



seal
x3



possibility of installing
additional accessories
pages 54-59



handrail
(in loft ladders in
version 280 and 305cm)



360 cm
↑
for high rooms

Technical specification:
permissible loading of 200 kg
loft ladder heat transmission coefficient U = 0.64 W/m²K*
Fire resistance class E₁/E₁ = 60 minutes
insulation thickness 7.8 cm
hatch thickness 8.5 cm

fully assembled,
and ready for quick
installation in the ceiling



3 years
WARRANTY

LMF 60 LADDER DIAGRAM

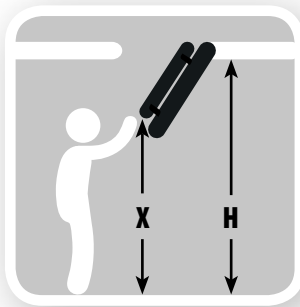

The LMF60 ladders up to the height of 360 cm are as standard equipped with ladder unloading mechanism, so they can be fully operated with the opening rod (hatch opening and closing, ladder unfolding).

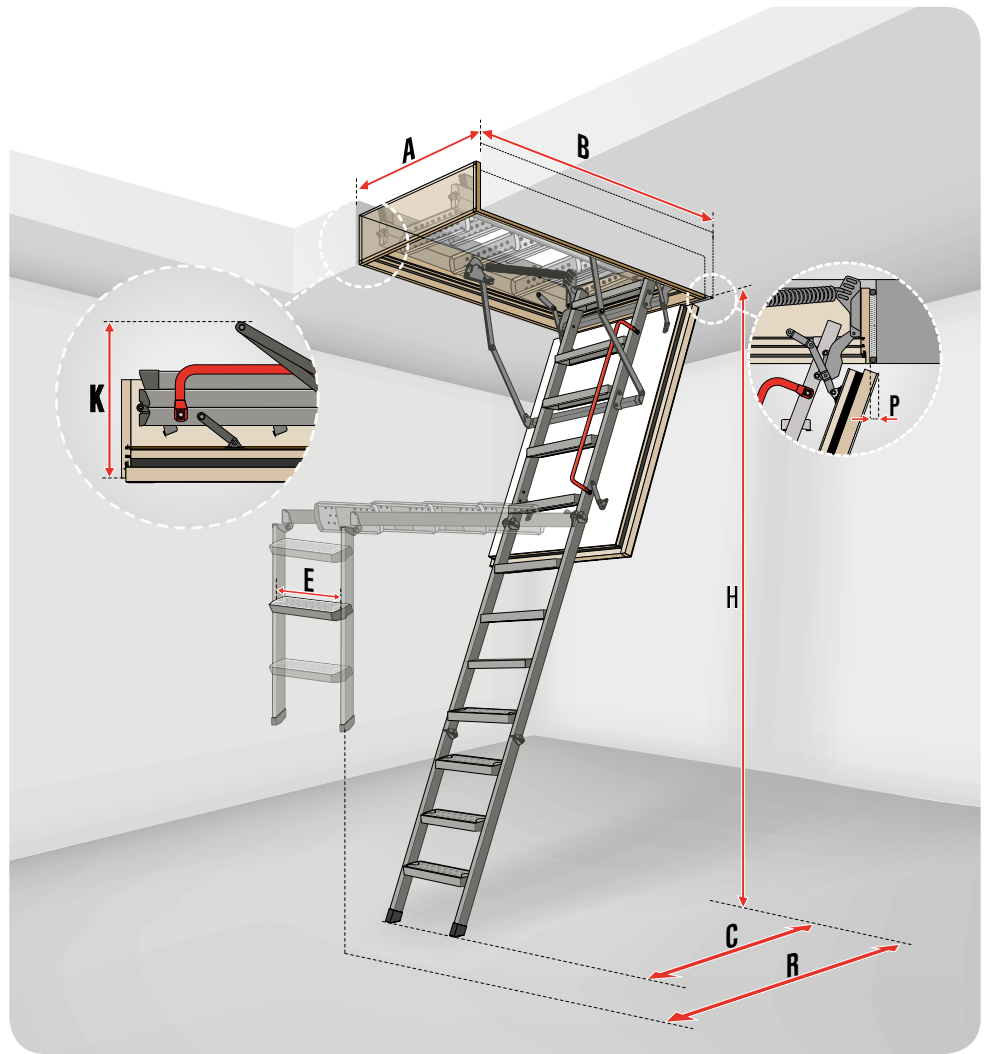

LMF 60 LOFT LADDER DIMENSIONS

Ceiling opening dimensions [cm]	AxB	60x120	70x120	70x130	70x140	86x130	70x130	70x140	86x130	60x144	70x144	86x144
Maximum room height [cm]	H			280				305			360	
Minimum room height [cm]*	H _{min.}			233				234			295	
Height to be reached to operate the ladder [cm]	X			210				230			265	
Box external dimensions [cm]		58x118	68x118	68x128	68x138	84x128	68x128	68x138	84x128	58x142.2	68x142.2	84x142.2
Box internal dimensions [cm]		54x114	64x114	64x124	64x134	80x124	64x124	64x134	80x124	54x138.2	64x138.2	80x138.2
Folded ladder height [cm]	K							39				
Swing space [cm]	R			156				167			194	
Distance after ladder unfolding [cm]	C			125				135			156	
Hatch retraction after opening	P							5				
Box height [cm]								22.5				
Number of sections								3				

LADDER PARAMETERS

Tread length [cm]	E							34				
Tread width [cm]	S							8				
Distance between treads [cm]	G					25					24	

* For rooms lower than the standard maximum height "H", it is required to match the ladder length in accordance with the fitting instructions.

LOFT LADDER

Commercial sizes [cm]		60x120	70x120	70x130	70x140	86x130	70x130	70x140	86x130	60x144	70x144	86x144
Room height [cm]	H			280				305			360	
Code		869J01	869J11	869J12	869J13	869J96	869J53	869J54	869J97	869JAD	869JAE	869JAF

Ladders are available only in sizes shown above.

FIRE-RESISTANT LOFT LADDERS

LMF
FIRE-RESISTANT

U=0.79
HATCH
W/m²K

NORMA
EN 14975

EN 13501-2
EI₂ **120**

The design of **LMF** loft ladder complies with stringent fire requirements, whilst providing safe and comfortable access to the loft spaces. The LMF ladder prevents fire from spreading to the upper or lower fire free storey for **120 minutes**.

Integrated with steel frame the quick installation system reduces time required to settle loft ladder in the ceiling.

Short distance between the last tread and attic floor.

The special hatch design and materials used in its production protect for 120 min against the ingress of fire.

Mechanism hidden within the rail aids folding and unfolding of the ladder.

* manufacturer's internal research



telescopic stile ends



ladder unloading mechanism built in handrail



fire-resistant hatch on both sides



system of quick installation in the ceiling



architrave lining



non-slip treads, 13 cm in width



seal



possibility of installing additional accessories pages 54-59

Technical specification:
permissible loading of 200 kg
hatch heat transmission coefficient U = 0.79 W/m²K
fire-resistance EI₂=120 minutes
insulation thickness 8 cm
hatch thickness 8.2 cm

fully assembled,
and ready for quick
installation in the ceiling



3 years
WARRANTY

LMF LOFT LADDER DIAGRAM

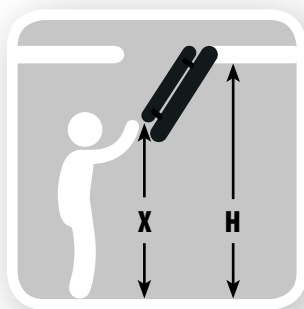

The LMF loft ladders are as standard equipped with ladder unloading mechanism, so they can be fully operated with the opening rod (hatch opening and closing, ladder unfolding).

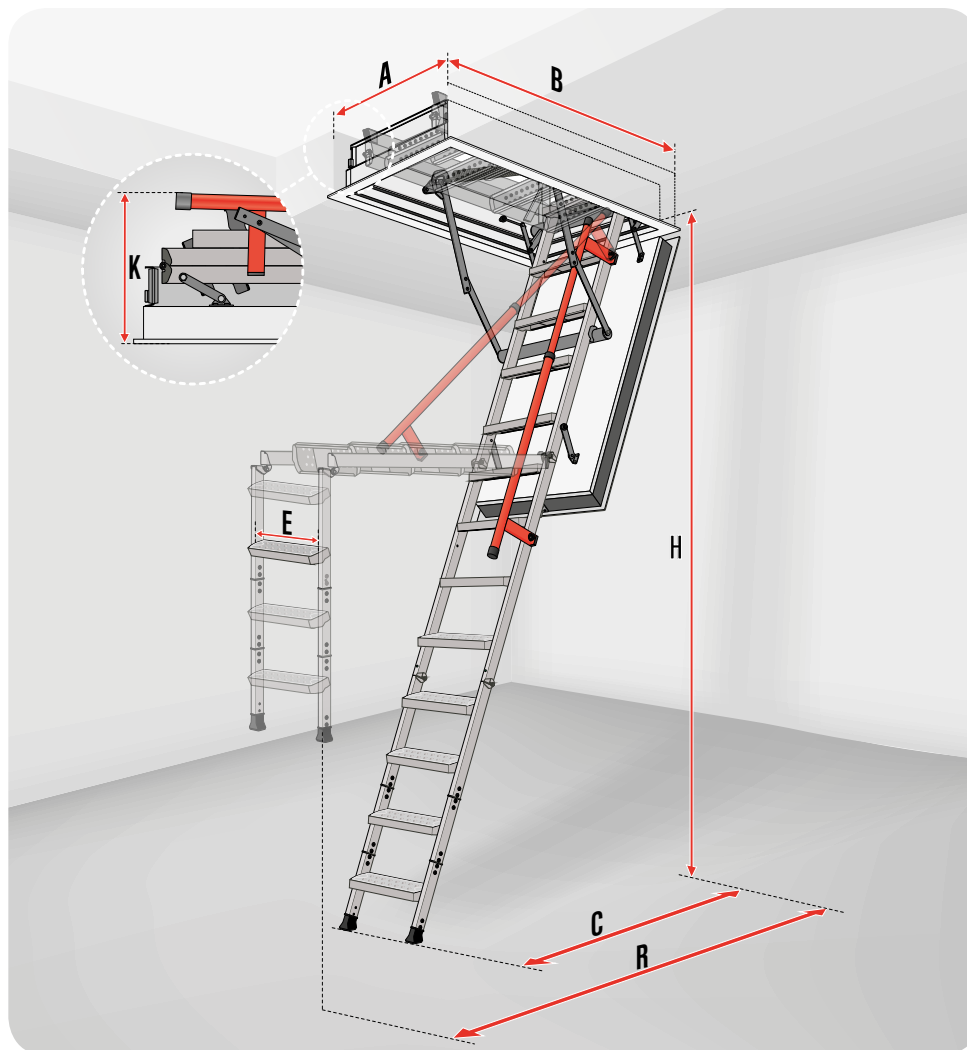

LMF LOFT LADDER DIMENSIONS

Ceiling opening dimensions [cm]	AxB	60x120	70x120	70x130	70x140	86x130	70x130	70x140	86x130
Maximum room height [cm]	H			280				305	
Minimum room height [cm]*	H _{min.}			233				256	
Height to be reached to operate the ladder [cm]	X			220				235	
Box external dimensions [cm]		59x118	68x118	68x128	68x138	84x128	68x128	68x138	84x128
Box external dimensions with architrave linings		64.7x123.7	73.7x123.7	73.7x133.7	73.7x143.7	89.7x133.7	73.7x133.7	73.7x143.7	89.7x133.7
Internal box dimensions [cm]		55x114	64x114	64x124	64x134	80x124	64x124	64x134	80x124
Folded ladder height [cm]	K					34			
Swing space [cm]	R			165				176	
Distance after ladder unfolding [cm]	C			120				130	
Box height [cm]						16			

LADDER PARAMETERS

Tread length [cm]	E					35			
Tread width [cm]						13			
Distance between treads [cm]						25			

* for rooms lower than the maximum standard height H please adjust the length of the ladder according to the assembly instructions

LOFT LADDER

Commercial sizes [cm]		60x120	70x120	70x130	70x140	86x130	70x130	70x140	86x130
Room height [cm]	H			280				305	
Code		862501	862511	862512	862513	862596	862553	862554	862597

Ladders are available only in sizes shown above.

SCISSORS LOFT
LADDERS



SCISSORS
LOFT LADDERS

► BOX

The ladder box can be of wood, metal or a combination of a wooden box / metal frame. The box is equipped with a **peripheral seal** and **lining as standard**. The box enables the scissors ladder to be installed and adjusted quickly and with ease.

► HATCH UNLOADING MECHANISM

The hinge mechanism significantly simplifies ladder operation. Once unlocked, the hatch opens slowly to avoid any risk to the user. It then keeps the hatch in the fully open position and prevents spontaneous spring back during folding and unfolding.

► HARDWARE

The patented **corner hinge** design adds rigidity to the box and prevents distortion. This ensures that the ladder will continue to be operated trouble-free.

► HATCH

Scissors loft ladders are equipped with white **insulated** or **fire-resistant** hatches, made of either wood or wood and metal as standard. The external hatch surface is smooth to blend effectively with the visual style of any interior design.

► TREADS

The **specially embossed** pattern on the tread surface protects the user from accidental slipping while using the loft ladder.

► LADDER

The scissors ladder construction makes height adjustment a simple process **with no need for cutting**. It also enables the ladder to be folded to a smaller size and used in openings as small as 50 x 70cm. The elegant, modern style is achieved through use of 'S'-shaped stringers which can also be used as handrails.

SCISSORS
LOFT LADDERS



SCISSORS LOFT LADDERS

LST

U=1.1
HATCH
W/m²K

STANDARD
**EN
14975**

The **LST** scissors loft ladder is equipped with a 3.6cm thick, white insulated hatch as standard. The box is made of wood and has quick-fit brackets while the hatch opening mechanism guarantees safe folding and unfolding. In addition, its construction has eliminated the need for a lock. The ladder itself is powder-coated in RAL 7022 Grey. The overall floor – ceiling ladder height can be increased to a maximum of 330cm by adding two LSS treads.



Wooden box with metal architrave lining and quick-fit brackets.



white hatch



possibility of adding or detaching tread



architrave lining



system of quick installation in the ceiling



peripheral seal



system of adapting the ladder length to the ceiling height



non-slip treads



possibility of installing additional accessories

Technical specification:
permissible loading of 200 kg
hatch heat transmission coefficient U = 1.1 W/m²K
insulation thickness 3 cm
hatch thickness 3.6 cm

fully assembled,
and ready for quick
installation in the ceiling



3 years
WARRANTY

LST LOFT LADDER DIAGRAM

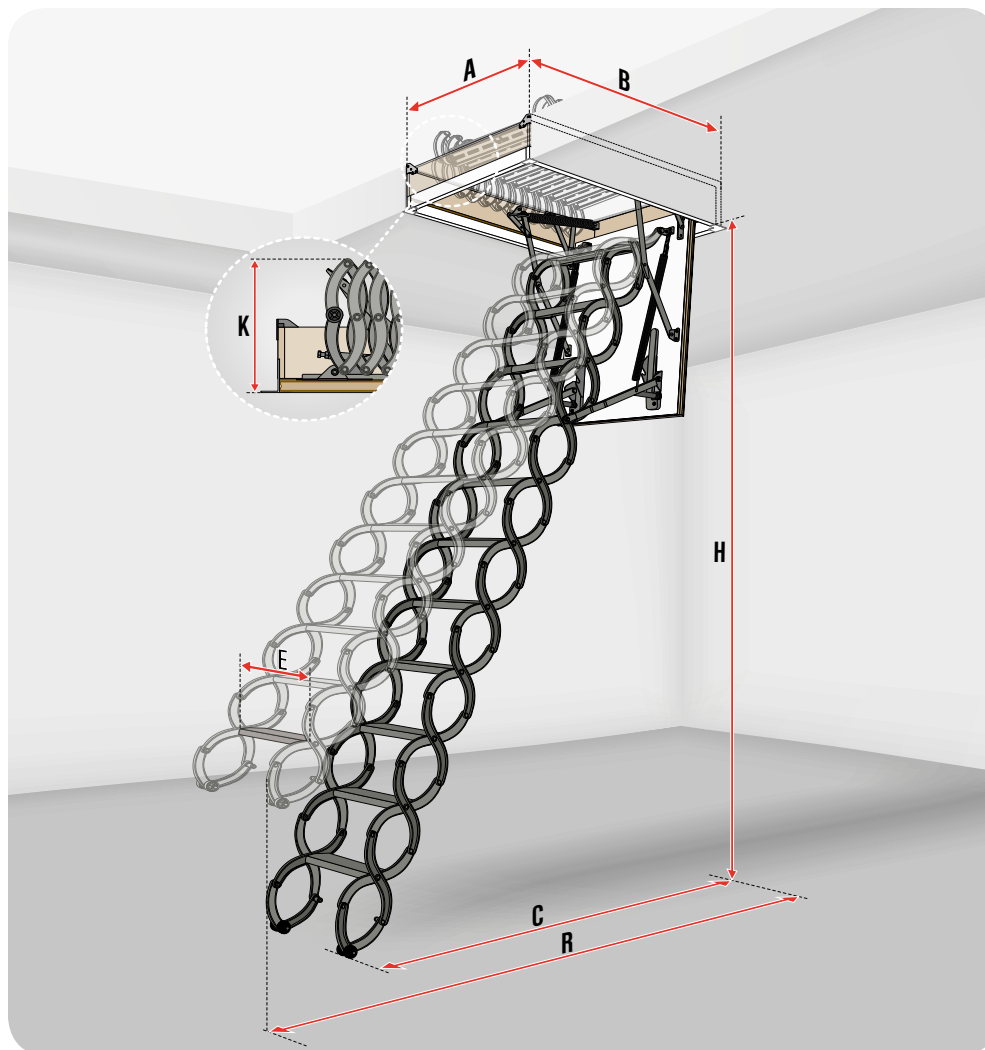

LST LOFT LADDER DIMENSIONS

		Standard ladder length				
Ceiling opening dimensions [cm]	AxB	50x80	60x90	60x120	70x80	70x120
Room height [cm]	H	250 – 280				
Box external dimensions [cm]		49x79.4	59x89.4	59x119.4	69x79.4	69x119.4
Box external dimensions with architrave linings		54x84.4	64x94.4	64x124.4	74x84.4	74x124.4
Internal box dimensions [cm]		44x74	54x84	54x114	64x74	64x114
Folded ladder height [cm]	K	38.2				
Swing space [cm]	R	150				
Distance after ladder unfolding [cm]	C	146 – 134				
Box height [cm]		18				

LADDER PARAMETERS

Tread length [cm]	E	24	30	38
Tread width [cm]		8		
Distance between treads [cm]		24-26		
Standard number of treads [units]		11		
Compatible tread LSS		LSS-24	LSS-31	LSS-38

LOFT LADDER

Commercial sizes [cm]		50x80	60x90	60x120	70x80	70x120
Room height [cm]	H	250 – 280				
Code		860402	860432	860423	860426	860436

Ladders are available only in sizes shown above.

Ladder shorter by 1 tread (10-tread ladder)	Standard ladder (11-tread ladder)	Ladder longer by 1 tread (12-tread ladder)	Ladder longer by 2 treads (13-tread ladder)
230	250	250	280
280	300	300	330
Sizes and dimensions of loft ladder not included into the table are identical with those for heights 250-280cm			
140	150	160	170
135	127	146	134
153	145	163	150

Code	860207	860205	860206
tread*	LSS-24	LSS-31	LSS-38
ladder width [cm]	50	60	70

* while ordering LSS tread- the ladder commercial size and type has to be provided

SCISSORS
LOFT LADDERS

SCISSORS LOFT LADDERS



LSZ

U=1.1
HATCH
W/m²K

STANDARD
EN
14975

The **LSZ** loft ladder is the same as the LST except for the box, the construction of which consists of an integrated metal frame within the wooden box. It also has finishing slats and quick-fit brackets. The overall floor - ceiling ladder height can be increased to a maximum of 330cm by adding two LSS treads.

Metal frame integrated with wooden box plus lining and quick-fit brackets.



white hatch



possibility of adding or detaching tread



finishing lining slats



system of quick installation in the ceiling



peripheral seal



system of adapting the ladder length to the ceiling height



non-slip treads



possibility of installing additional accessories pages 54-59

Technical specification:
permissible loading of 200 kg
hatch heat transmission coefficient U = 1.1 W/m²K
insulation thickness 3 cm
hatch thickness 3.6 cm

fully assembled,
and ready for quick
installation in the ceiling



3 years
WARRANTY

LSZ LOFT LADDER DIAGRAM

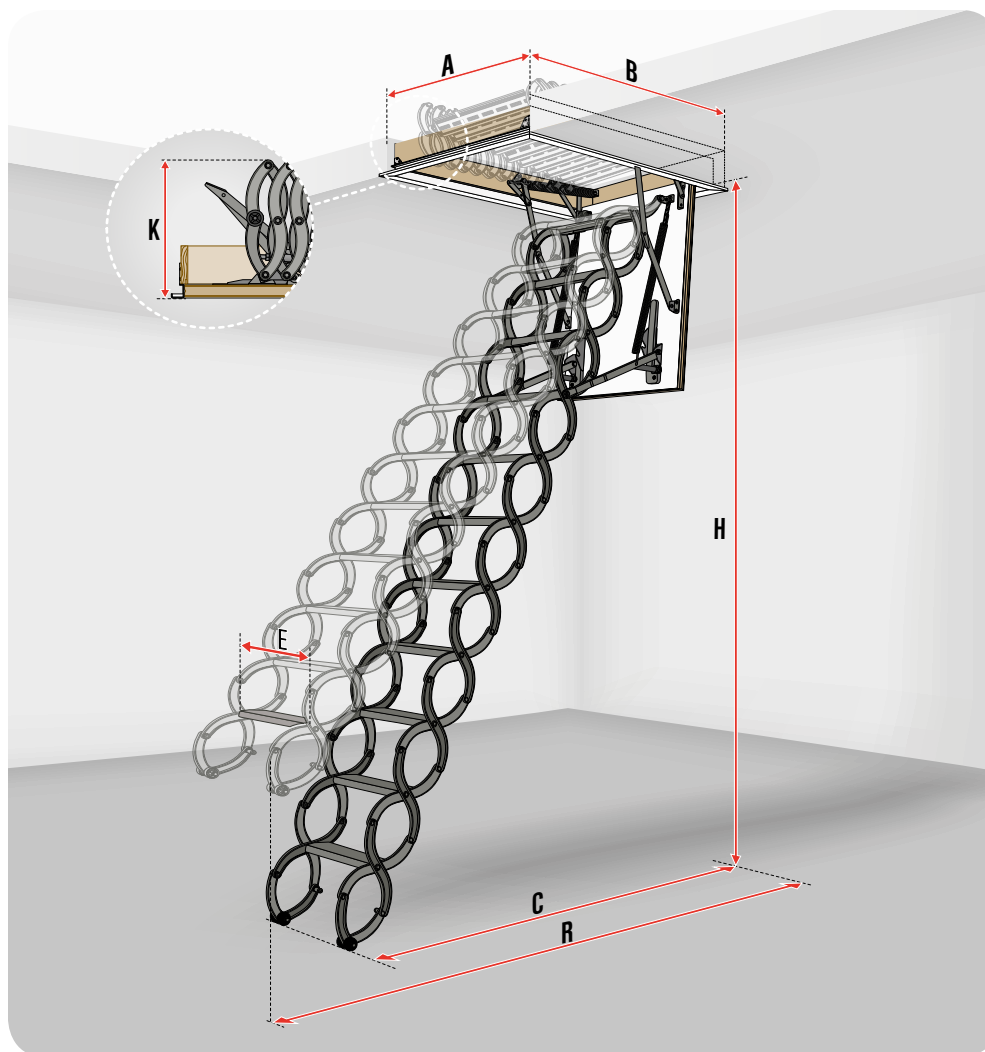

LSZ LOFT LADDER DIMENSIONS

		Standard ladder length		
Ceiling opening dimensions [cm]	AxB	51x80	70x80	70x120
Room height [cm]	H	250 – 280		
Box external dimensions [cm]		51x79.4	69x79.4	69x119.4
Box external dimensions with architrave linings		54.6x82.6	72.6x82.6	72.6x122.6
Internal box dimensions [cm]		46x74	64.8x74	64.8x114
Folded ladder height [cm]	K	38.5		
Swing space [cm]	R	150		
Distance after ladder unfolding [cm]	C	146 – 134		
Box height [cm]		14		

LADDER PARAMETERS

Tread length [cm]	E	26	38
Tread width [cm]		8	
Distance between treads [cm]		24-26	
Standard number of treads [units]		11	
Compatible tread LSS		LSS-26	LSS-38

LOFT LADDER

Commercial sizes [cm]		51x80	70x80	70x120
Room height [cm]	H	250 – 280		
Code		860502	860532	860536

Ladders are available only in sizes shown above.

Ladder shorter by 1 tread (10-tread ladder)	Standard ladder (11-tread ladder)	Ladder longer by 1 tread (12-tread ladder)	Ladder longer by 1 tread (12-tread ladder)
230	250	250	280
		280	300
		300	330
Sizes and dimensions of loft ladder not included into the table are identical with those for heights 250-280cm			
	140	150	160
	135	127	146
		134	153
		145	163
		170	150

Code	860204	860206
tread*	LSS-26	LSS-38
ladder width[cm]	51	70

* while ordering LSS tread- the ladder commercial size and type has to be provided

METAL SCISSORS
LOFT LADDERS

SCISSORS LOFT LADDERS

LSF
FIRE-RESISTANT

U=1.8
HATCH
W/m²K

STANDARD
EN
14975

EN 13501-2
E1, **60**

The **LSF** fire-resistant loft ladder has a 60-minute fire rating and acts as a barrier to prevent spread of flame. The overall floor - ceiling ladder height can be increased to a maximum of 320cm by adding one LSS tread.

The loft ladder hatch is equipped with an expanding seal, which under the influence of high temperature increases its volume and prevents fire from spreading to the fire free storey.

*manufacturer's internal research



fire-resistant hatch on one side



system of quick installation in the ceiling



architrave lining



system of adapting the ladder length to the ceiling height



non-slip treads



possibility of installing additional accessories pages 54-59



possibility of adding or detaching tread

Technical specification:
permissible loading of 200 kg
fire-resistance EI₁=60 minutes
insulation thickness 3 cm
hatch thickness 5.6cm

fully assembled,
and ready for quick
installation in the ceiling



3 years
WARRANTY

LSF LOFT LADDER DIAGRAM

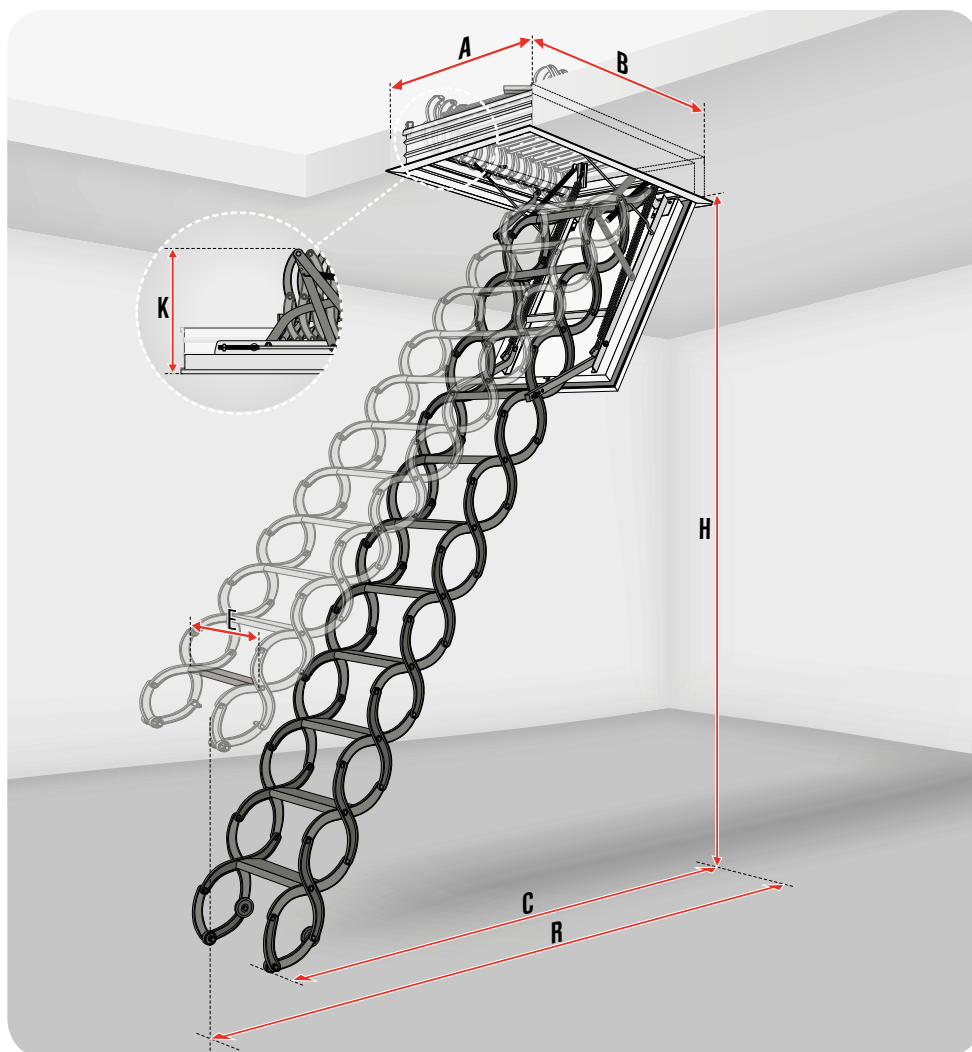

LSF LOFT LADDER DIMENSIONS

		Standard ladder length						
Ceiling opening dimensions [cm]	AxB	50x70	60x90	60x120	70x80	70x90	70x110	70x120
Room height [cm]	H	270 – 300						
Box external dimensions [cm]		48x68.5	58x88.5	58x118.5	68x78.5	68x88.5	68x108.5	68x118.5
Box external dimensions with architrave linings		54.8x75	64.8x95	64.8x125	74.8x85	74.8x95	74.8x115	74.8x125
Internal box dimensions [cm]		44.8x64.8	54.8x84.8	54.8x114.8	64.8x74.8	64.8x84.8	64.8x104.8	64.8x114.8
Folded ladder height [cm]	K	46						
Swing space [cm]	R	170 – 180						
Distance after ladder unfolding [cm]	C	165 – 130						
Box height [cm]		14						

LADDER PARAMETERS

Tread length [cm]	E	30	32	40
Tread width [cm]		8		
Distance between treads [cm]		25 – 30		
Standard number of treads [units]		10		
Compatible tread LSS		LSS-30	LSS-32	LSS-40

LOFT LADDER

Commercial sizes [cm]	50x70	60x90	60x120	70x80	70x90	70x110	70x120
Room height [cm]	270 – 300						
Code	860101	860123	860126	860132	860133	860135	860136

Ladders are available only in sizes shown above.

Ladder shorter by 1 tread (9-tread ladder)		Standard ladder (10-tread ladder)		Ladder longer by 1 tread (11-tread ladder)	
240	270	270	300	300	320
Sizes and dimensions of loft ladder not included into the table are identical with those for heights 250-280cm					
165	165	170	180	185	210
100	140	165	130	120	140

Code	860201	860202	860203
tread*	LSS-30	LSS-32	LSS-40
ladder width [cm]	50	60	70

* when ordering LSS tread- the ladder commercial size and type has to be provided

WOODEN
DOORS



L-SHAPED COMBINATION DOORS

DWK

DWK L-Shaped combination doors are intended to be built into walls to provide access to the unused space behind. They offer excellent thermal insulation parameters ($U=1.1W/m^2K$) and airtightness to minimise heat loss. Left or right-hand opening versions are available, standard doors being equipped with 3.5cm wide natural timber-coloured slats. The 3.6cm insulated sash is of HDF and has a white veneer on both sides and pine frame.

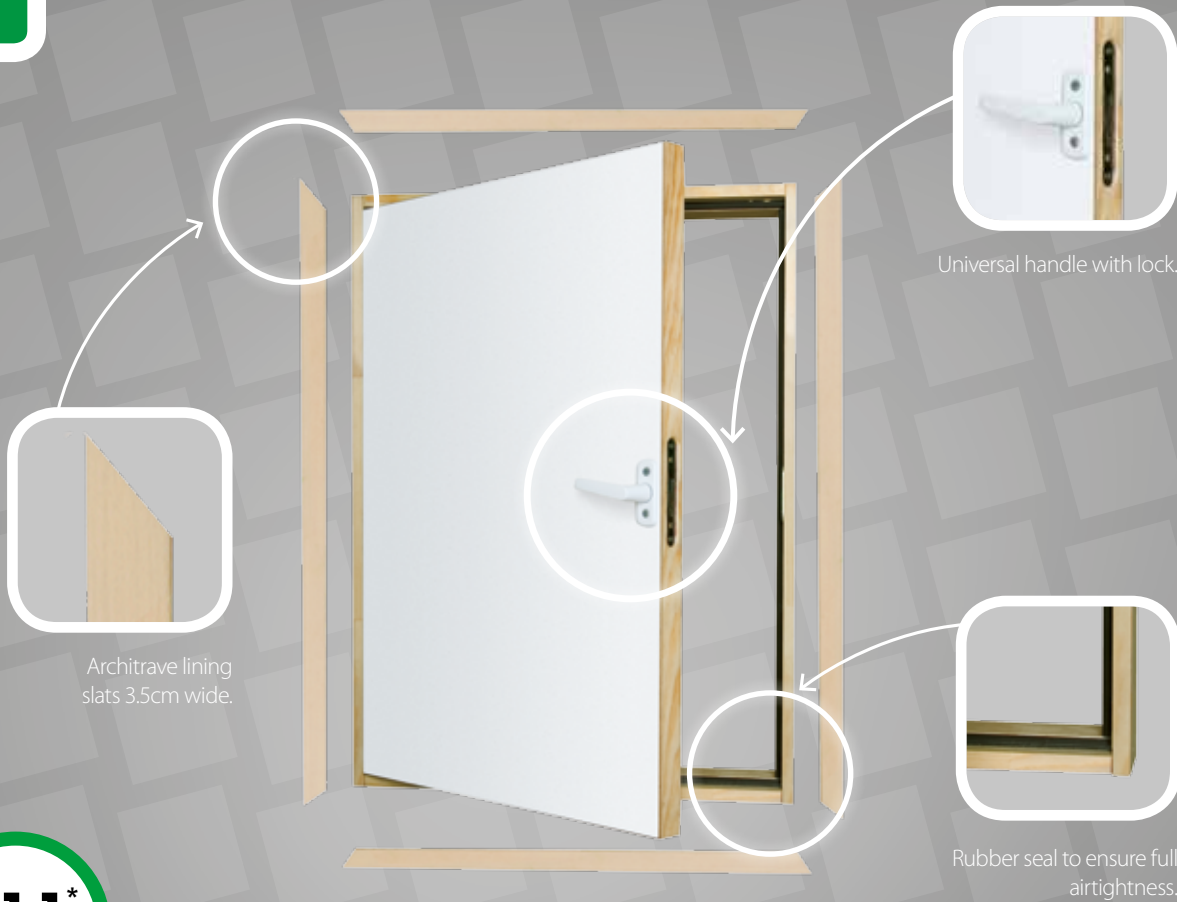

$U=1.1^*$
 W/m^2K

* manufacture's internal testing for the middle part of the sash



architrave lining



Technical specification:
heat transmission coefficient $U = 1.1 W/m^2K$
insulation thickness 3 cm

fully assembled,
and ready for quick
installation



3 years
WARRANTY

DWK DOOR DIAGRAM

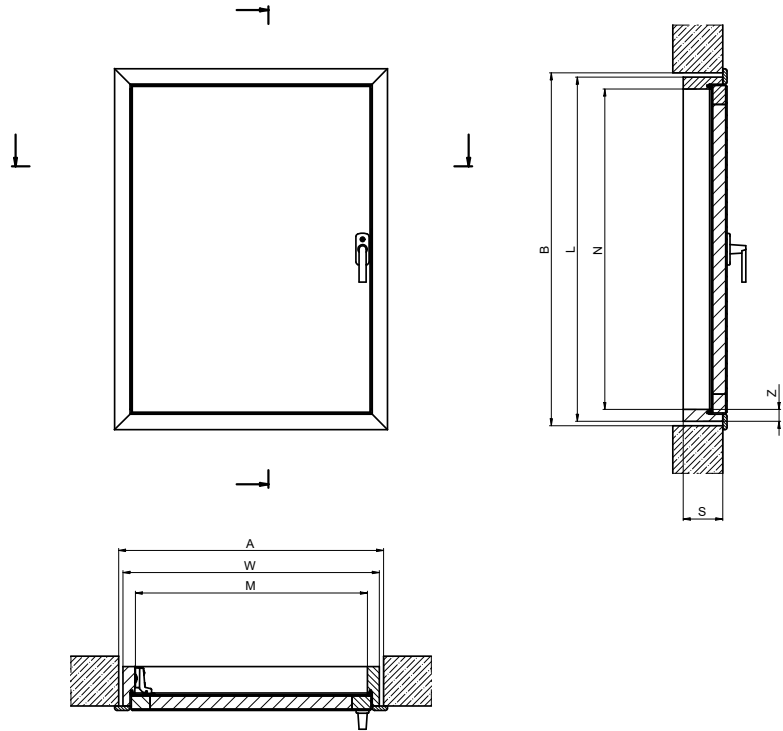

DWK L-SHAPED DOORS DIMENSIONS

Opening dimensions [cm]	AxB	55x80	60x80	60x100	60x110	70x90	70x100	70x110
Door dimensions [cm]	WxL	53.4x78.4	58.4x78.4	58.4x98.4	58.4x108.4	68.4x88.4	68.4x98.4	68.4x108.4
Frame internal dimensions [cm]	MxN	48x73	53x73	53x93	53x103	63x83	63x93	63x103
Frame width [cm]	S	8.5						
Frame thickness [cm]	Z	2.7						

L-SHAPED DOORS

Commercial sizes [cm]	55x80	60x80	60x100	60x110	70x90	70x100	70x110
Code	869900	869922	869924	869925	869933	869934	869935

DWK doors are available only in sizes shown above.

WOODEN
DOORS



HIGHLY ENERGY-EFFICIENT WOODEN DOORS

DWT
HIGHLY ENERGY
EFFICIENT

The **DWT** highly energy efficient L-shaped doors are designed primarily for installation in L-shaped walls, provide access to the room behind and at the same time constitute an excellent barrier against heat loss (heat transfer coefficient $U = 0.6 \text{ W / m}^2\text{K}^*$) and guarantee high tightness. The door can be installed in the right or left side. They are as standard equipped with wooden architrave lining in natural colour.

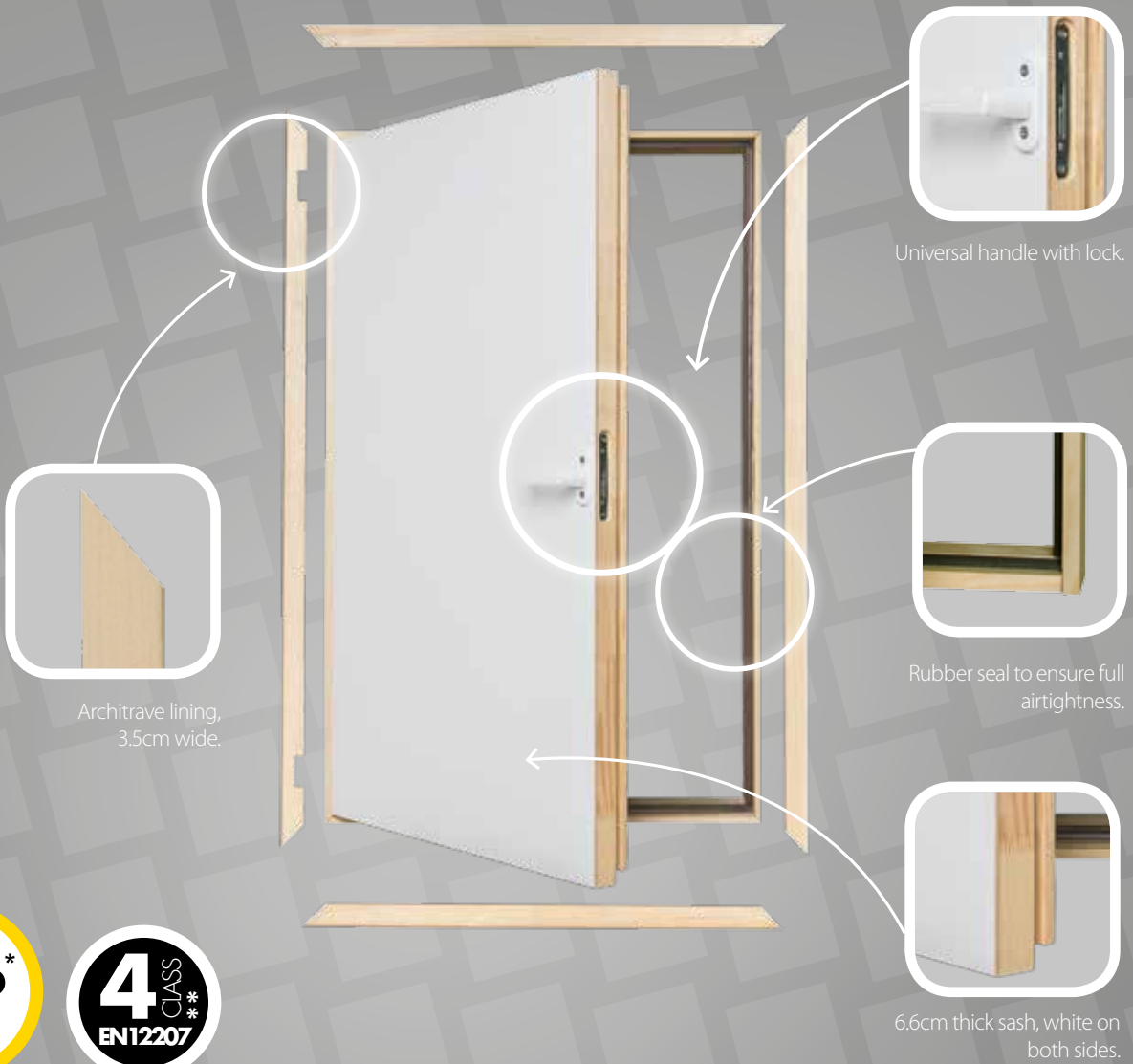

U=0.6*
W/m²K

4 CLASS
EN12207

*manufacturer's internal testing for sash
** manufacturer's internal research



architrave lining



Technical specification:
heat transmission coefficient $U = 0.6 \text{ W/m}^2\text{K}^*$
insulation thickness 6 cm

fully assembled,
and ready for quick
installation



3 years
WARRANTY

DWT DOOR DIAGRAM

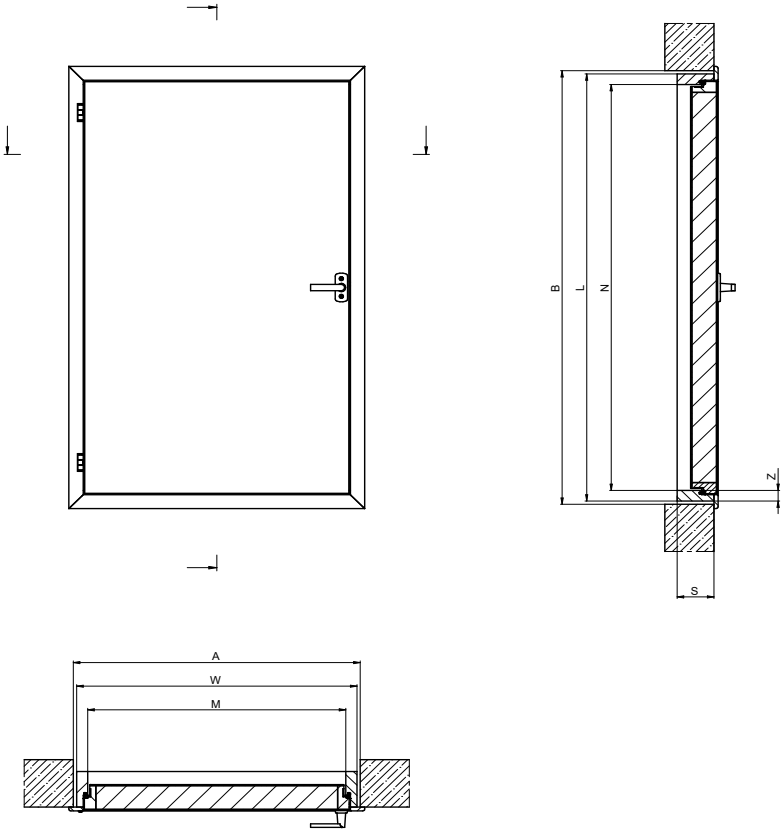

DWT L-SHAPED DOORS DIMENSIONS

Opening dimensions [cm]	AxB	55x80	60x80	60x100	60x110	70x90	70x100	70x110
Door dimensions [cm]	WxL	53.4x78.4	58.4x78.4	58.4x98.4	58.4x108.4	68.4x88.4	68.4x98.4	68.4x108.4
Frame internal dimensions [cm]	MxN	48x73	53x73	53x93	53x103	63x83	63x93	63x103
Frame width [cm]	S	9						
Frame thickness [cm]	Z	2.7						

L-SHAPED DOORS

Commercial sizes [cm]	55x80	60x80	60x100	60x110	70x90	70x100	70x110
Code	869600	869622	869624	869625	869633	869634	869635

DWT doors are available only in sizes shown above.

WOODEN
DOORS



L-SHAPED COMBINATION DOORS

DWF L-Shaped combination fire-resistant doors have a 45-minute fire rating – (EN 13501-2) to protect against the spread of flame while providing access to unused space behind a wall. The white 6.6cm thick sash has thermo insulation to provide an excellent barrier against heat loss ($U = 0.64 \text{ W/m}^2\text{K}^*$). The door can be installed in the right or left side. They are as standard equipped with wooden architrave lining in natural colour.

DWF
FIRE-RESISTANT

$U = 0.64^*$
W/m²K



Architrave lining
3.5cm wide

EN 13501-2
EI, 45

4 CLASS
EN12207

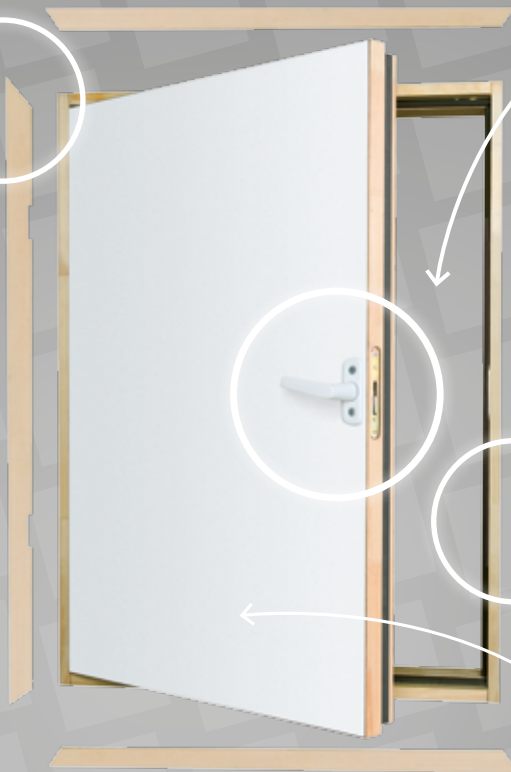

Universal handle with lock.



Rubber seal to ensure full airtightness.



White, double-sided fire-resistant door sash 6.6cm thick, equipped with a self-expanding seal.

*manufacturer's internal testing for sash
** manufacturer's internal research



architrave lining



fire-resistant white sash
on both sides



Technical specification:
fire-resistance EI, /EI, =45 minutes
heat transmission coefficient $U = 0.64 \text{ W/m}^2\text{K}^*$
insulation thickness 6 cm

fully assembled,
and ready for quick installation in the ceiling



DWF DOOR DIAGRAM

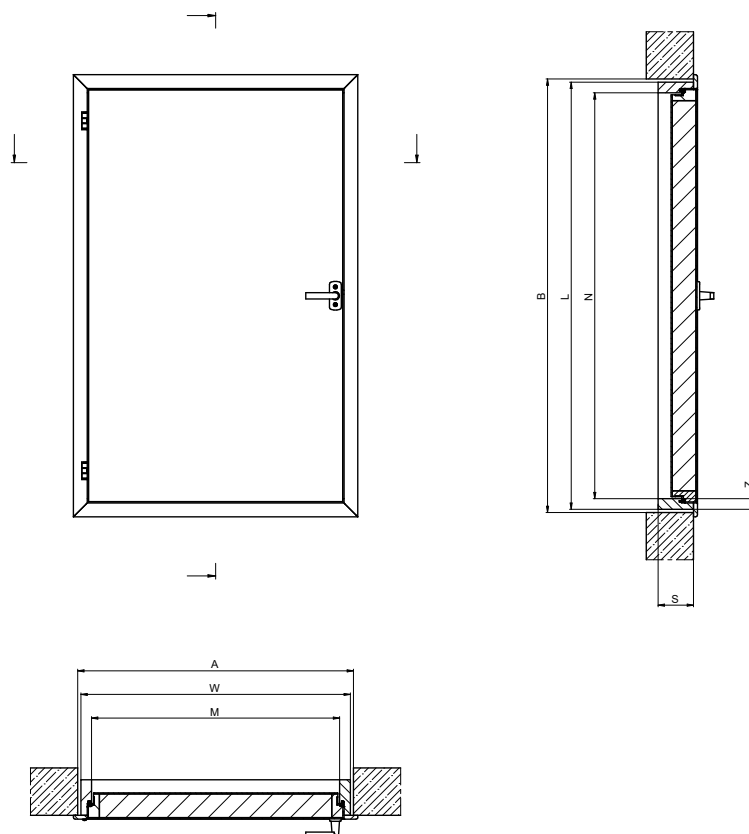

DWF L-SHAPED DOORS DIMENSIONS

Opening dimensions [cm]	AxB	55x80	60x80	60x100	60x110	70x90	70x100	70x110
Door dimensions [cm]	WxL	53.4x78.4	58.4x78.4	58.4x98.4	58.4x108.4	68.4x88.4	68.4x98.4	68.4x108.4
Frame internal dimensions [cm]	MxN	48x73	53x73	53x93	53x103	63x83	63x93	63x103
Frame width [cm]	S	9						
Frame thickness [cm]	Z	2.7						

L-SHAPED DOORS

Commercial sizes [cm]	55x80	60x80	60x100	60x110	70x90	70x100	70x110
Code	869800	869822	869824	869825	869833	869834	869835

DWF doors are available only in sizes shown above.

BALUSTRADE LXB-U

The loft balustrade is made of pine wood, protects the ceiling opening in the attic and makes it easier and safer to descend the ladder. The LXB-U is installed directly to the loft floor and is strengthened with flat-bars. The LXB-U balustrade is suitable for the biggest loft ladder size 86x140 cm and 92x130 cm, so it can be applied to all types of loft ladder without cutting its horizontal bars.



UNIVERSAL
SIZE
without
necessity
of cutting

LXB-U Balustrade	Available for loft ladders
	all FAKRO loft ladders
Standard dimensions [cm]	86 x 140
Non-standard dimensions [cm]	for loft ladder sizes smaller than 86x140 cm, the standard size balustrade is applied
Balustrade height [cm]	110

Code 80AZ04

HANDRAIL LXH-A

The LXH-A handrail improves the comfort and safety of access to the loft. Mounted to the floor near the ceiling opening, makes every trip up and down the attic easier. For installation on the right and on the left side of the opening.



NEW!

Code 869287*

*available in second half of 2021

INSTALLATION BRACKETS

LXK

Installation brackets facilitate loft ladder installation in the ceiling. Installed in the corners of the box, they add to its overall rigidity ensuring equal lengths of diagonals. Bolts are screwed into brackets guaranteeing quick and accurate levelling of the loft ladder in the ceiling.

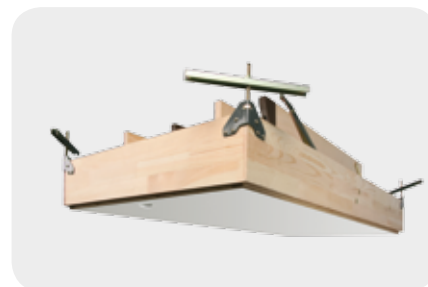

Installation brackets	Available for loft ladders										
	LWK Komfort	LWL Extra	LTK Energy	LWT	LWT Passive House	LWF 60	LDK	LMS	LMK	LMP	LMF 60
Installation to the ceiling max. thickness [cm]	35		39		43			35		39	43

Code 62085

ARCHITRAVE LININGS LXL

The architrave is designed to finish the installation of the loft ladder and to cover gaps in the ceiling which remain after the fitting process. The architrave elements are of solid pine wood (LXL-P) or in white (LXL-W) or PVC (LXL-PVC). This quick and simple fitting process ensures a fast, aesthetically pleasing finish of the installed Loft Ladder. In the case of PVC architrave, connection with the box does not require any nails. The LXL-PVC architrave is available in white*.

Architrave linings LXL-P/-W	Available for loft ladders											
	LWK Komfort	LWL Extra	LTK Energy	LWT	LWT PassiveHouse	LWF60	LDK	LMS	LMK	LMS	LMK	LMP
Standard dimensions [cm]	70x140, 86x144											
Non-standard dimensions [cm]	For other loft ladders sizes , cut the slats from the standard architrave lining size.											
Slats thickness after installation on box [cm]	1											
Slats width [cm]	3.5											
Max. width of the gaps, the architrave slats cover after installation on the box [cm]	2.5											



	LXL-P		LXL-W	
	70x140	86x144	70x140	86x144
Code	62087	80AZ52	62088	80AZ54

Architrave linings LXL-PVC	Available for loft ladders											
	LWK Komfort	LWL Extra	LTK Energy	LWT	LWT PassiveHouse	LWF60	LDK	LMS	LMK	LMP	LMF60	
Standard dimensions [cm]	60x120, 70x120, 86x140, 86x144											
Non-standard dimensions [cm]	For other loft ladders sizes, cut the slats from the standard architrave lining size.											
Slats thickness after installation on box [cm]	1											
Slats width [cm]	3.3											
Max. width of the gaps, the architrave slats cover after installation on the box [cm]	2.4											



	LXL-PVC			
	60x120	70x120	86x140	86x144
Code	62082	62083	62084	80AZ56

* the architrave lining colour may slightly differ from the colour of lining in angles and hatch

INVISIBLE ARCHITRAVE LXL-I

The LXL-Invisible linings allow for discreet installation and concealment loft ladders in the ceiling. Thanks to the use of linings, the ladder box remains invisible. There is no need to install architrave linings masking the gaps, and the loft ladder hatch is hidden in the ceiling. The use of a discrete assembly system allows for an aesthetic and minimalistic interior finish. Installation of LXL -Invisible linings with loft ladders should be done before finishing the ceiling with plasterboards.

Invisible architrave LXL-I	Available for loft ladders		
	LWK Komfort, LWL Extra, LTK Energy, LWT		
Standard dimensions [cm]	60x120cm, 70x120cm, 86x140cm		
Non-standard dimensions [cm]	For other loft ladders sizes, cut the slats from the standard architrave lining size.		
The thickness of the plasterboards to which the lining is adapted	12.5		
	LXL-I		
	60x120	70x120	86x140
Code	80AZ68	80AZ69	80AZ70

NEW!



BOX EXTENSION LXN

Made of pine, the box extension matches perfectly with the box of the installed ladder and enhances the look of the ceiling opening. In addition, in case of thick ceilings, for 4-segment and scissors LST and LSZ loft ladders, the box extension serves as an extension element of a box height allowing for installation of the LXW upper hatch (see LXW, page 57).



Box extension LXN	Available for loft ladders																	
	LWK Komfort	LWZ Plus	LWL Extra	LTK Energy	LWT	LWT Passive House	LWF 60	LDK	LMS	LMK	LML	LMF 60	LMF	LST	LSZ			
Height of the box extension frame [cm]	10																	
Max. height of non-standard box extension [cm]	20							16		20								
LXN box extension commercial size [cm]	51x80	55x100	55x111	60x90	60x94	60x100	60x111	60x120	60x130	60x140	70x80	70x94	70x100	70x111	70x120	70x130	70x140	86x130
Code	862300	862320	862321	862322	862307	862306	862304	862301	862302	862303	862332	862317	862316	862314	862311	862312	862313	862396

When ordering standard and non-standard box extensions, please specify the model and commercial size of loft ladders. The provided box extension size will be compatible with the loft ladder box.

ADDITIONAL TREAD LXT

An additional tread makes climbing the ladder easier and increases comfort and safety when accessing the loft space. Made of wood, it is installed between the final tread and loft floor and is particularly recommended for use in situations where the upper hatch is installed on the ladder box or where ladders are installed in a thick ceiling.

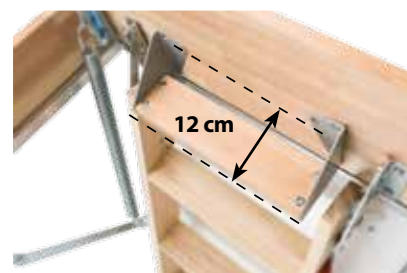

Additional tread LXT	Available for loft ladders						
	LWK Komfort (size 55x111)	LWL Extra (sizes 60x...)	LWK Komfort (except size 55x111)	LWL Extra (except sizes 60x...)	LWZ Plus	LMS	LMK
	LXT 280			LXT 300			
Loft ladder's tread length [cm]	30			34			
	LXT 280	LXT 300					
Code	62058	62059					

UPPER HATCH LXW

The LXW Upper Hatch prevents attic dust from accumulating on the hatch and steps of the closed ladder. It improves the overall insulating parameters and airtightness of the ladder on which it is installed. The upper hatch consists of a frame equipped with a peripheral gasket, 3.6cm thick hatch door, hardware, installation brackets, gas piston and rotational closing handle. In order to close the upper hatch from the loft side, it is possible to install an additional LXZ handle.

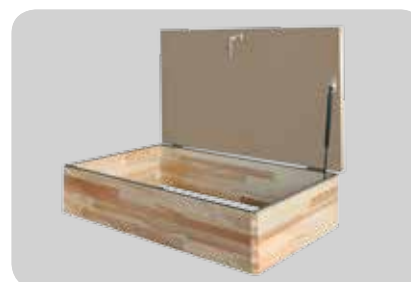

Upper hatch LXW	Available for loft ladders																	
	LWK Komfort	LWZ Plus	LWL Extra	LTK Energy	LWT	LWT Passive House	LWF 60	LMS	LMK	LML	LMF 60	LMF	LST	LSZ				
Max. thickness of the ceiling where the upper hatch can be installed (cm)	31 or after standard box extension installation 41. For 4 section ladders the use of the box extension is a must.		31 or after standard upper hatch installation 41.		35 or after standard box extension installation 45. With 4-section loft ladders extension box must be applied.		39 or after standard box extension installation 49. With 4-section loft ladders extension box must be applied.			31 or after standard box extension installation 41.		48 or after standard box extension installation 58.	39 or after standard box extension installation 49.	33 or after standard box extension installation 43.	41, the box extension installation is a must			
Upper hatch box height (cm)	20																	
Commercial sizes of LXW (cm)	51x80	55x100	55x111	60x90	60x94	60x100	60x111	60x120	60x130	60x140	70x80	70x94	70x100	70x111	70x120	70x130	70x140	86x130
Code	862200	862220	862221	862222	862207	862206	862204	862201	862202	862203	862232	862217	862216	862214	862211	862212	862213	862296

When ordering standard and non-standard upper hatches, please specify the model and commercial size of loft ladders. The provided upper hatch size will be compatible with the loft ladder box.

HANDLE LXZ

The LXZ handle enables the LXW upper hatch to be closed from the loft side e.g. during maintenance work in the loft or on the roof.

Code	80AZ01
-------------	---------------



STILE ENDS LXS

The **LXS Stile Ends** are finishing elements mounted on the base of the ladder, adding a smart touch to its appearance. They add to the ladder's stability and are made from specially selected material to protect the floor from being scratched. They are available for all segment of loft ladders with wooden ladder sections (besides 4-section and LDK loft ladder).

Code	62027
-------------	--------------



UNLOADING MECHANISM LXM

The unloading mechanism assists in folding and unfolding the ladder thus increasing the comfort and safety of using loft ladders. Available for 3- segment loft ladders. **The LXM** installation possible on the right or left side of the ladder, on the opposite side to the LXH handrail.

Unloading mechanism LXM	Available for loft ladders	
	LWK Komfort, LWZ Plus, LTK Energy, LWT, LWT PH, LWF60	
LXM_3	only for 3- segment loft ladders, minimum room height 260cm	

Code	869373
-------------	---------------

NEW!



HANDRAIL LXH

The LXH Metal Handrail makes climbing the ladder easier and increases user's safety and comfort. It is mounted onto upper ladder section.



Handrail LXH	Available for loft ladders		
	LWK Komfort, LWZ Plus, LTK Energy, LWT, LWT Passive House, LWF 60, LMS, LMK, LMF60		LDK
Handrail is installed to the upper ladder section	LXH *50/13	LXH *75/13	LXH 75/16
Code	80AZ24	80AZ18	62065

* Handrails LXH 50/13 are installed to ladder with boxes up to 100cm in length; handrails LXH 75/13 to ladders with boxes over 100cm in length
In the LMF 60 loft ladders, the additional LXH handrail is compatible only with the loft ladders version heights up to 280 and 305cm

ASSEMBLY KIT LXX-D

The LXX-D assembly kit simplifies and improves the installation of LML loft ladders to the ceiling, on which the DRL hatch has already been installed. Installation in ceilings with a thickness of min. 38cm, maximum 50cm.

Code	80AZ41
-------------	---------------



INSULATION KIT LXD

The **LXD Insulation Kit** provides the standard of tight insulation between the ladder box and ceiling opening needed in energy-efficient construction. It includes: airtight collar, insulation material (sheep wool blocks) and an air permeable collar.



Installation kit LXD	Available for loft ladders						
	LWK Komfort	LWL Extra	LTK Energy	LWT	LDK	LMS	LMK
Standard dimensions [cm]	60/70x120 oraz 86 x 140						
Non-standard dimensions	For ladders smaller than 86x140 cm the standard size of the kit has to be adapted						
Commercial sizes LXD	60x120	70x120	86x140	86x144			
Code	80AZ13	80AZ14	80AZ15	80AZ61			

AVAILABLE ADDITIONAL ACCESSORIES

	LWK Komfort	LWZ Plus	LWL Extra	LTK Energy	LWT	LWT PH	LWF 60	LDK	LMS	LMK	LML	LMP	LMF 60	LMF	LST	LSZ	LSF
LXB-U balustrade	✓	✓	✓	✓	✓	✓	✓	✓	✓	✓	✓	✓	✓	✓	✓	✓	✓
LXK installation brackets	✓	—	✓	✓	✓	✓	✓	✓	✓	✓	—	✓	✓	—	—	—	—
LXL architrave lining (wooden)	✓	—	✓	✓	✓	✓	✓	✓	✓	✓	—	✓	✓	—	—	—	—
LXL-PVC architrave lining (plastic)	✓	—	✓	✓	✓	✓	✓	✓	✓	✓	—	✓	✓	—	—	—	—
LXL-I architrave	✓	—	✓	✓	✓	—	—	—	—	—	—	—	—	—	—	—	—
LXH handrail	✓	✓	—	✓	✓	—	✓	✓	✓	✓	—	—	✓**	—	—	—	—
LXN box extension	✓	✓	✓	✓	✓	✓	✓	✓	✓	✓	✓	✓	✓	✓	✓	✓	—
LXT additional tread	✓	✓	✓	—	—	—	—	—	✓	✓	—	—	—	—	—	—	—
LXW upper hatch	✓*	✓	✓	✓*	✓*	✓	✓*	—	✓	✓	✓	✓	✓	✓	✓*	✓*	—
LXS stile ends (only for 3 sections ladders)	✓	✓	✓	✓	✓	✓	✓	—	—	—	—	—	—	—	—	—	—
LXM unloading mechanism (only for 3 sections ladders)	✓	✓	—	✓	✓	✓	✓	—	—	—	—	—	—	—	—	—	—
LXX-D assembly kit	—	—	—	—	—	—	—	—	—	—	✓	—	—	—	—	—	—
LXD insulation kit	✓	—	✓	✓	✓	—	—	✓	✓	✓	—	✓	—	—	—	—	—

* for 4 section loft ladders and scissors the LXN box extension is mounted prior to the upper hatch LXW installation

** In the LMF60 loft ladders, the additional LXH handrail is compatible only with the loft ladders version heights up to 280 and 305cm



FAKRO®

Fakro GB Ltd
Fakro House
Astron Business Park
Hearthcote Road
Swadlincote DE11 9DW
telephone : 01283 554755 fax : 01283 224545
www.fakro.co.uk e-mail: sales@fakrogb.com

FAKRO reserves the right to change specifications and technical parameters of products without prior notice.